

MultiConnect® mDot™

MTDOT Developer Guide

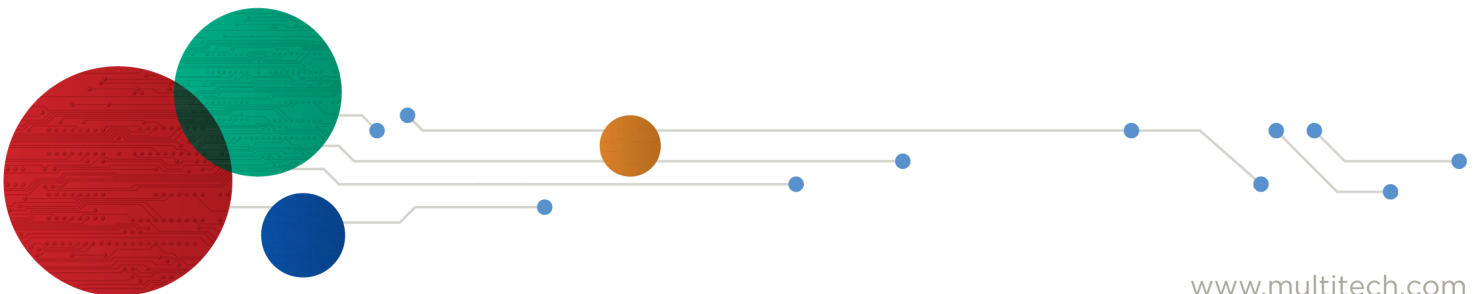

MultiConnect mDot Developer Guide

Models: MTDOT-915-xxx, MTDOT-868-xxx includes also the MTUDK2-ST-MDOT Developer Kit

Part Number: S000612, Version 3.5

Copyright

This publication may not be reproduced, in whole or in part, without the specific and express prior written permission signed by an executive officer of Multi-Tech Systems, Inc. All rights reserved. **Copyright © 2017 by Multi-Tech Systems, Inc.**

Multi-Tech Systems, Inc. makes no representations or warranties, whether express, implied or by estoppels, with respect to the content, information, material and recommendations herein and specifically disclaims any implied warranties of merchantability, fitness for any particular purpose and non-infringement.

Multi-Tech Systems, Inc. reserves the right to revise this publication and to make changes from time to time in the content hereof without obligation of Multi-Tech Systems, Inc. to notify any person or organization of such revisions or changes.

Trademarks and Registered Trademarks

MultiTech, and the MultiTech logo, and MultiConnect are registered trademarks and mDot and Conduit are trademarks of Multi-Tech Systems, Inc. All other products and technologies are the trademarks or registered trademarks of their respective holders.

Legal Notices

The MultiTech products are not designed, manufactured or intended for use, and should not be used, or sold or re-sold for use, in connection with applications requiring fail-safe performance or in applications where the failure of the products would reasonably be expected to result in personal injury or death, significant property damage, or serious physical or environmental damage. Examples of such use include life support machines or other life preserving medical devices or systems, air traffic control or aircraft navigation or communications systems, control equipment for nuclear facilities, or missile, nuclear, biological or chemical weapons or other military applications ("Restricted Applications"). Use of the products in such Restricted Applications is at the user's sole risk and liability.

MULTITECH DOES NOT WARRANT THAT THE TRANSMISSION OF DATA BY A PRODUCT OVER A CELLULAR COMMUNICATIONS NETWORK WILL BE UNINTERRUPTED, TIMELY, SECURE OR ERROR FREE, NOR DOES MULTITECH WARRANT ANY CONNECTION OR ACCESSIBILITY TO ANY CELLULAR COMMUNICATIONS NETWORK. MULTITECH WILL HAVE NO LIABILITY FOR ANY LOSSES, DAMAGES, OBLIGATIONS, PENALTIES, DEFICIENCIES, LIABILITIES, COSTS OR EXPENSES (INCLUDING WITHOUT LIMITATION REASONABLE ATTORNEYS FEES) RELATED TO TEMPORARY INABILITY TO ACCESS A CELLULAR COMMUNICATIONS NETWORK USING THE PRODUCTS.

The MultiTech products and the final application of the MultiTech products should be thoroughly tested to ensure the functionality of the MultiTech products as used in the final application. The designer, manufacturer and reseller has the sole responsibility of ensuring that any end user product into which the MultiTech product is integrated operates as intended and meets its requirements or the requirements of its direct or indirect customers. MultiTech has no responsibility whatsoever for the integration, configuration, testing, validation, verification, installation, upgrade, support or maintenance of such end user product, or for any liabilities, damages, costs or expenses associated therewith, except to the extent agreed upon in a signed written document. To the extent MultiTech provides any comments or suggested changes related to the application of its products, such comments or suggested changes is performed only as a courtesy and without any representation or warranty whatsoever.

Contacting MultiTech

Knowledge Base

The Knowledge Base provides immediate access to support information and resolutions for all MultiTech products. Visit <http://www.multitech.com/kb.go>.

Support Portal

To create an account and submit a support case directly to our technical support team, visit: <https://support.multitech.com>.

Support

Business Hours: M-F, 8am to 5pm CT

Country	By Email	By Phone
Europe, Middle East, Africa:	support@multitech.co.uk	+(44) 118 959 7774
U.S., Canada, all others:	support@multitech.com	(800) 972-2439 or (763) 717-5863

Warranty

To read the warranty statement for your product, visit www.multitech.com/warranty.go. For other warranty options, visit www.multitech.com/es.go.

World Headquarters

Multi-Tech Systems, Inc.
 2205 Woodale Drive, Mounds View, MN 55112
 Phone: (800) 328-9717 or (763) 785-3500
 Fax (763) 785-9874

Contents

Chapter 1 – Product Overview	7
Overview	7
What's New in Firmware Version 3.0	7
LoRaWAN 1.0.2 Support	7
Listen Before Talk	7
Separate Channel Plans	7
Getting Started.....	8
Documentation Overview	8
Related Documentation	9
mbed Documentation	9
Programming the mDot Microcontroller	9
General mBed Links	9
mDot Platform	10
EUI and Networking	10
Product Build Options	10
Chapter 2 – Mechanical Drawings with Pinouts	12
MTDOT-xxx-X1P-SMA.....	12
MTDOT-xxx-X1-SMA.....	13
MTDOT-xxx-X1-UFL	14
MTDOT-xxx-M1-UFL.....	15
MTDOT-xxx-M1-TRC.....	16
Chapter 3 – Specifications and Pin Information.....	17
MTDOT Specifications	17
LoRa Transmission Output Power.....	20
868 Models	20
915 Models	20
Battery Draw Down.....	21
Electrical and Timing Characteristics	22
Pin Information	23
SPI Flash	24
Pull-Up/Down.....	25
LoRa.....	25
Crystals/Oscillator	26
Route Pads	26
mDot Pinout Design Notes.....	27
Serial Pinout Notes.....	27
Serial Settings.....	27

LoRa	27
Throughput Rates.....	27
Range	28
Resetting the mDot	28
Chapter 4 – Antennas	29
Antenna System	29
U.FL and Trace Antenna Options	29
Pulse Electronics Antenna.....	29
Antenna Specifications	29
OEM Integration	30
FCC & IC Information to Consumers	30
FCC Grant Notes.....	30
Host Labeling.....	30
Chapter 5 – Safety Information	31
Handling Precautions	31
Radio Frequency (RF) Safety	31
Sécurité relative aux appareils à radiofréquence (RF).....	31
Interference with Pacemakers and Other Medical Devices	32
Potential interference	32
Precautions for pacemaker wearers	32
Device Maintenance	32
User Responsibility.....	33
Chapter 6 – Regulatory Information	34
EMC, Safety, and Radio Equipment Directive (RED) Compliance	34
47 CFR Part 15 Regulation Class B Devices	34
FCC Interference Notice	34
FCC Grant	35
FCC Part 15.....	35
FCC Notice	35
Industry Canada Class B Notice.....	35
Industry Canada	36
Chapter 7 – Environmental Notices	37
Waste Electrical and Electronic Equipment Statement	37
WEEE Directive.....	37
Instructions for Disposal of WEEE by Users in the European Union	37
REACH Statement	37
Registration of Substances.....	37
Substances of Very High Concern (SVHC)	37
Restriction of the Use of Hazardous Substances (RoHS)	38
Information on HS/TS Substances According to Chinese Standards	39
Information on HS/TS Substances According to Chinese Standards (in Chinese)	40

Chapter 8 – Labels	41
Approvals and Certification.....	41
Example Labels.....	41
Chapter 9 – Developer Kit Overview	43
Developer Board Overview	43
Developer Board Features	43
MTUDK2-ST-MDOT Developer Kit Contents	43
Chapter 10 – Board Components	44
Developer Board	44
Developer Board Connectors.....	46
Board Components	46
LED Indicators	47
Chapter 11 – Chapter 11 Developer Board Installation	48
Installing an mDot on the Developer Board	48
Arduino Shield.....	49
mDot Arduino Pins.....	49
Installing an Arduino Shield with an mDot.....	49
RSMA to U.FL Cables.....	50
Connecting an Antenna through the Developer Board Connectors.....	50
Chapter 12 – Chapter 12 Developer Board Schematics	51
About Schematics.....	51
Block Diagram	52
Schematics	53
Chapter 13 – Chapter 13 Micro Developer Kit	58
Micro Developer Kit	58
Developer Kit Package Contents.....	58
Firmware Updates.....	58
Windows Drivers	58
Micro DK Mechanical Drawings	59
Micro Developer Board Components	60
Installing an mDot on a Micro Developer Board	60
Assembly Diagrams and Schematics.....	61
Assembly Diagrams.....	61
Schematics	62
Chapter 14 – Chapter 14 Design Considerations	67
Noise Suppression Design	67
PC Board Layout Guideline	67
Electromagnetic Interference	67
Electrostatic Discharge Control.....	68
USB Design	68

Chapter 15 – Appendix A Release Note Archive 69

- What's New in Firmware Version 2.0 69
 - LoRaWan 1.0.1 Enhancement 69
 - AU915 Support..... 69
 - Class C 69
 - AT Commands Added or Changed in Version 2.0 69
- Maintenance Release 1.0.8-1..... 70
- What's New in Firmware Version 1.0 70
 - About Adaptive Data Rate 70
 - Peer to Peer Communication..... 70
 - EU 868 Test Mode..... 71
 - Sleep Mode Enhancements 71
 - Preserve Session 72
 - AT Commands Added or Changed in Version 1.0 72

Index..... 73

Chapter 1 – Product Overview

Overview

The MultiConnect mDot is a programmable, long-range RF module that provides encrypted data connectivity to sensors, industrial equipment, and remote appliances. By using LoRa™ Long Range Spread Spectrum technology, bi-directional data communication can be maintained for distances up to 5 miles/8 km line of sight, deep into buildings, or within noisy environments* using the unlicensed ISM bands in North America, Europe and worldwide. mDot simplifies local connectivity for Internet of Things (IoT) applications.

The mDot features an integrated ARM® Cortex®-M4 processor and mbed™ compatible software library for developers to control, monitor and bring edge intelligence to their Internet of Things (IoT) applications.

*Actual distance depends on conditions, configuration, antennas, desired throughput, and usage frequency. In dense urban environments, a typical range is 1-2 miles.

What's New in Firmware Version 3.0

The new release includes the following changes:

- LoRaWAN 1.0.2 Support
- Listen Before Talk
- Separate Channel Plans

For more information on using these features, visit <https://developer.mbed.org/platforms/MTS-mDot-F411/>.

LoRaWAN 1.0.2 Support

Adds AS923, extending support to Brunei, Cambodia, Hong Kong, Indonesia, Japan, Laos, New Zealand, Singapore, South Korea, Taiwan, Thailand, and Vietnam.

Adds KR920, extending support to South Korea.

Listen Before Talk

Listen before talk (LBT) is required in Japan and South Korea. This feature is automatically configured by the channel plan.

- For Japan, the AS923 has LBT enabled by default.
- For all other AS923 countries, LBT is disabled by default.
- For South Korea, KR920 has LBT enabled by default.

Separate Channel Plans

Select a channel plan at compile time to integrate the channel plan with the firmware.

For an archive of release notes, go to Appendix A.

Getting Started

Getting started depends on what you want to do. By default, mDot ships with firmware that supports AT Commands that use the serial I/O. For AT Commands, refer to the separate *MultiConnect Dots AT Command Reference Guide*.

To send commands to the mDot:

1. Mount the mDot on the developer board. For details, refer to [Chapter 11, Developer Board Installation](#).
2. Connect a serial cable into the DB-9 connector.

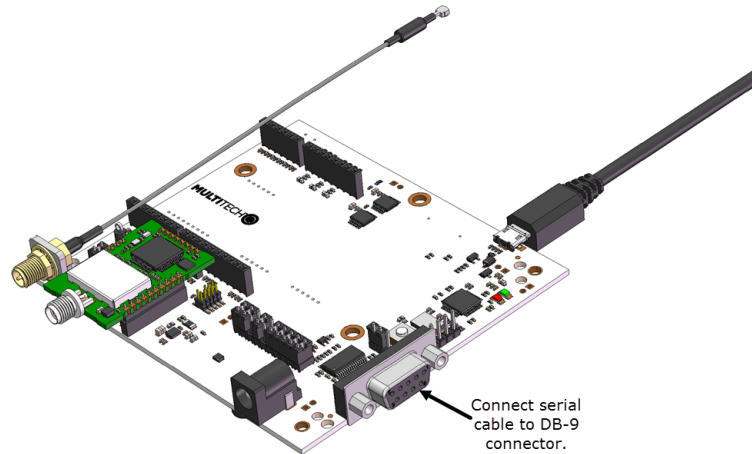

3. Open communications software, such as HyperTerminal or TeraTerm.
4. Set the following:
 - Baud rate = 115,200
 - Data bits = 8
 - Parity = N
 - Stop bits = 1
 - Flow control = Off

Two serial interfaces are available through the USB interface, one is used to program the mDot and the other is for debug messages. Refer to “mDot Pinout Design Notes” in *Chapter 3, Specifications and Pin Information* for information on which pins are available out of the box.

To develop using mbed, the mDot mbed page includes libraries and test cases. Refer to “mBed Documentation” for details and links.

For help setting up a MultiConnect® Conduit™ to send data to and from an mDot, refer to “Related Documentation.”

Documentation Overview

This manual is one part of mDot documentation. Refer to the *Related Documentation* and *mbed* sections for additional information needed to program your mDot and integrate your application with the MultiConnect Conduit gateway.

This document includes the following sections:

- **mDot device information:** Mechanical drawings, specifications, safety and regulatory information, and other device specific content. Chapters 1-8
- **Universal Developer Kit information:** Using the MTUDK-ST-MDOT Developer Kit, including design considerations, schematics, and installation and operation information. Chapters 9-13

This manual is available at www.multitech.com/support.

Related Documentation

- **DOT Series AT Command Reference:** Includes details on the AT commands available for mDots. This manual is available at www.multitech.com/support
- **MultiTech Developer Site:** Application notes, LoRa information, and documentation for related products such as the MultiConnect Conduit (MTCDDT) gateway and the LoRa accessory card (MTAC-LORA) are available on the MultiTech developer site. This site includes information on using the Conduit with mDots. Go to: www.multitech.net
- **Processor Datasheet:** STmicro ARM® Cortex®-M4 processor datasheet is available on the STMicro website: <http://www.st.com/web/en/catalog/mmc/FM141/SC1169/SS1577/LN1877/PF260049>

mbed Documentation

ARM mbed is a free, open-source platform and operating system for embedded devices using the ARM Cortex-M microcontrollers. The mbed website provides free software libraries, hardware designs, and online tools for rapid prototyping of products. The platform includes a standards-based C/C++ SDK, a microcontroller HDK, and supported development boards, an online compiler and online developer collaboration tools.

Note: To send and receive data, you need a LoRaWAN 1.0 gateway, such as MultiTech's MultiConnect Conduit (MTCDDT) with an MTAC-LORA accessory card installed.

Programming the mDot Microcontroller

With the mDot and the MTUDK2-ST-xx developer board, use the ARM mbed ecosystem to program the microcontroller. Compile in the cloud or locally, copy the resulting binary file to the mbed USB drive, and reset the mDot.

Note: To program the mDot, you need an mDot model with programming header, model MTDOT-xx-X1P-SMA.

On the mDot mbed page, MultiTech supplies source code for non-RF portions of the mDot and MTAC-LORA cards. To comply with FCC and ETSI certification, some portions of the software is available only as binary libraries.

MultiTech offers both development and stable release versions of the library.

- Development version: libmDot-dev-mbed5
- Stable release version: libmDot-mbed5

You can use either the mbed online compiler or offline tools.

- Online: Use the mbed-os library in your mbed application
- Offline: Use mbed-cli tools to create, manage, and build your mbed 5.1 application.

General mBed Links

- Explore mbed: <http://developer.mbed.org/explore>
- Getting Started with mbed: <http://developer.mbed.org/getting-started>
- mbed Handbook: <http://developer.mbed.org/handbook/Homepage>

- mbed online compiler documentation: <https://developer.mbed.org/handbook/mbed-Compiler>
- mbed cli documentation: <https://github.com/ARMmbed/mbed-cli/blob/master/README.md>
- mbed workspace tools documentation: <https://github.com/ARMmbed/mbed-os/blob/master/docs/BUILDING.md#workspace-tools>

mDot Platform

The mDot mbed page includes the mDot library, firmware, and test cases <https://developer.mbed.org/platforms/MTS-mDot-F411>

EUI and Networking

All mDots have a factory-programmed Extended Unique Identifier (EUI). This is marked as **Node** on the mDot label.

To connect an mDot to a network, you will need to program it with the network ID for the network you are connecting to as well as the network key and application key. For information on setting up mDots as part of a LoRa network, go to: www.multitech.net

Product Build Options

Product	Description	Quantity to Order
North America		
MTDOT-915-X1-SMA	915 MHz LoRa SMA	1 or 50
MTDOT-915-X1P-SMA	915 MHz LoRa SMA with Programming Header	1
MTDOT-915-X1-UFL	915 MHz LoRa U.FL	1 or 50
MTDOT-915-M1-UFL	915 MHz SMT LoRa U.FL	1 or 100
MTDOT-915-M1-TRC	915 MHz SMT LoRa RF Pad	1 or 100
EMEA		
MTDOT-868-X1-SMA	868 MHz LoRa SMA	1 or 50
MTDOT-868-X1P-SMA	868 MHz LoRa SMA with Programming Header	1
MTDOT-868-X1-UFL	868 MHz LoRa U.FL	1 or 50
MTDOT-868-M1-UFL	868 MHz SMT LoRa U.FL	1 or 100
MTDOT-868-M1-TRC	868 MHz SMT LoRa RF Pad	1 or 100
Australia		
MTDOT-915-AU-X1-SMA	AU 915 MHz LoRa SMA	1 or 50
MTDOT-915-AU-X1P-SMA	AU 915 MHz LoRa SMA with Programming Header	1
MTDOT-915-AU-X1-UFL	AU 915 MHz LoRa U.FL	1 or 50
MTDOT-915-AU-M1-UFL	AU 915 MHz SMT LoRa U.FL	1 or 100
MTDOT-915-AU-M1-TRC	AU 915 MHz SMT LoRa RF Pad	1 or 100
Developer Kits		
MTUDK2-ST-MDOT	mDot Developer Kit	1

Product	Description	Quantity to Order
MTMDK-ST-MDOT	mDot Micro Developer Kit	1

Note:

- The complete product code may end in .Rx. For example, MTDOT-915-M1-X1.Rx, where R is revision and x is the revision number.

Chapter 2 – Mechanical Drawings with Pinouts

MTDOT-xxx-X1P-SMA

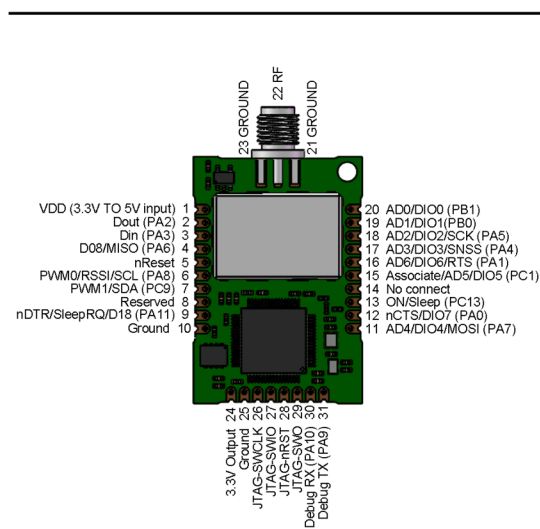
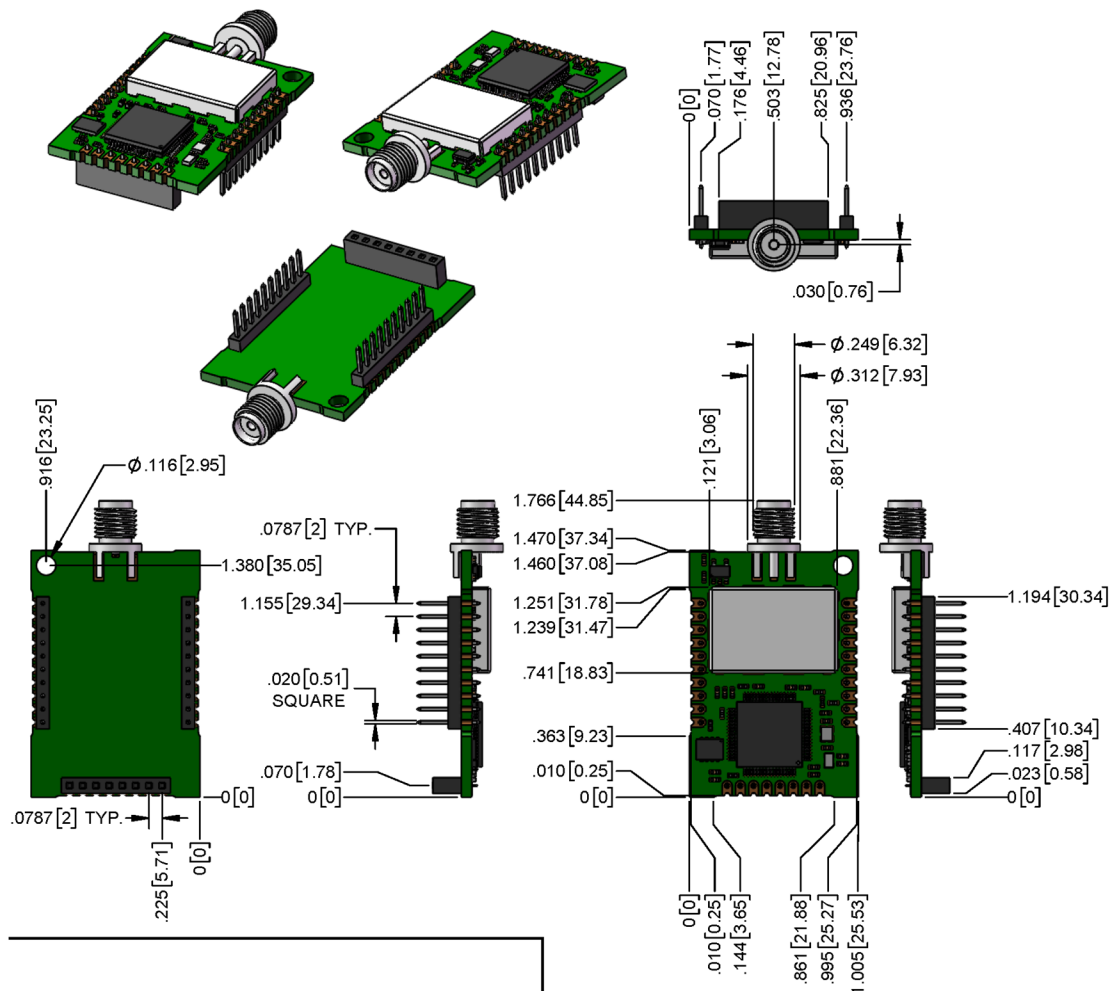

MTDOT-X1P-SMA

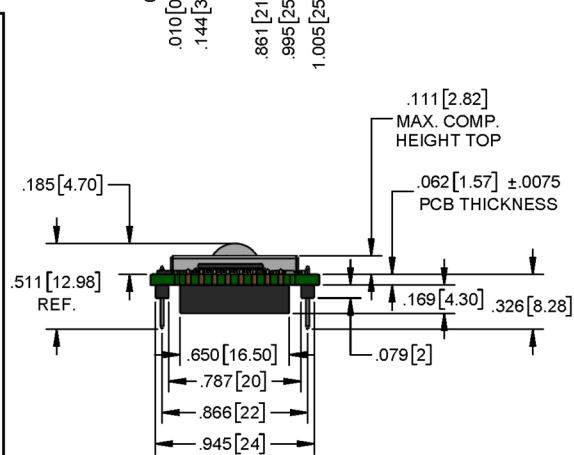

DIMENSIONS IN In [mm]

MTDOT-xxx-X1-SMA

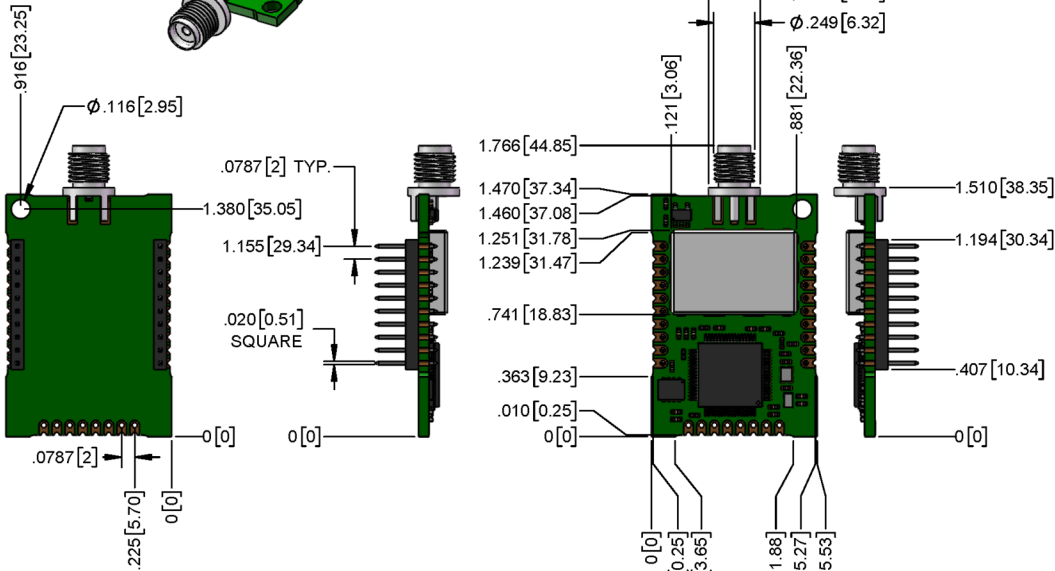
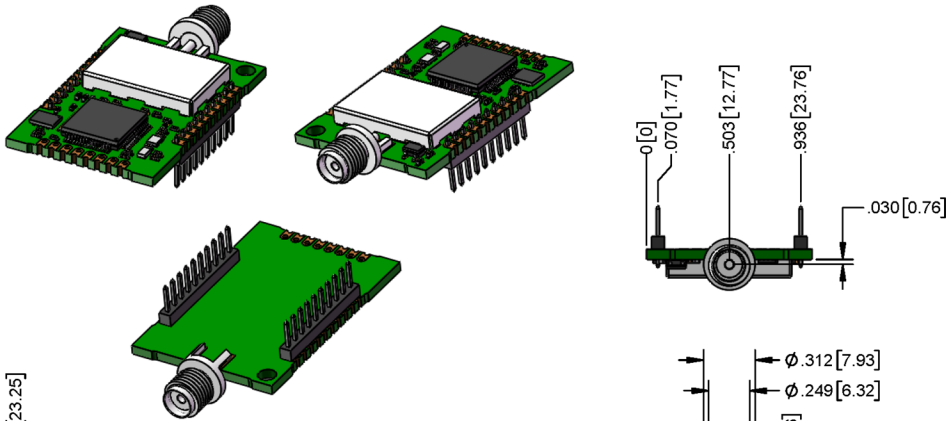

MTDOT-X1-SMA

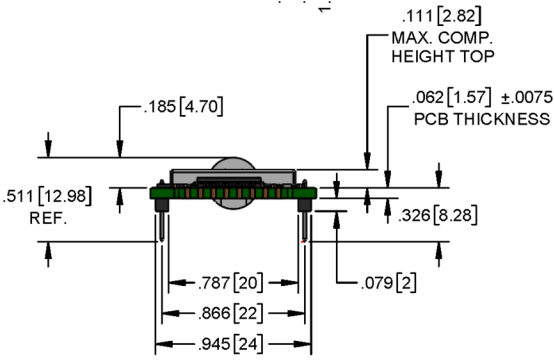

DIMENSIONS IN In [mm]

MTDOT-xxx-M1-UFL

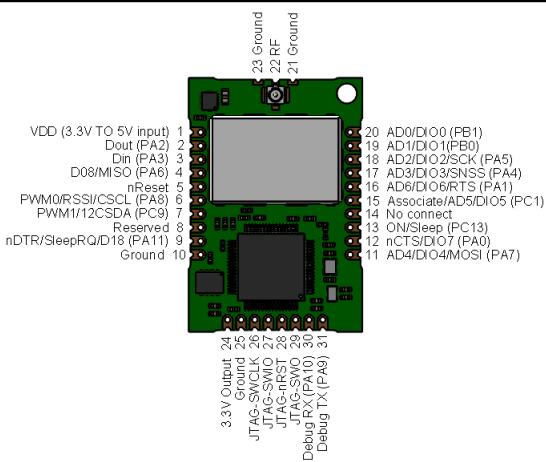
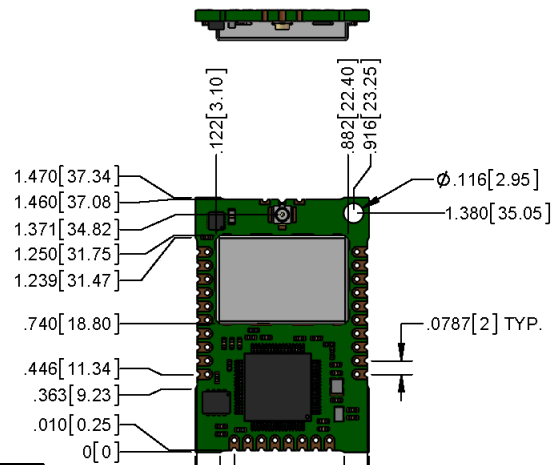
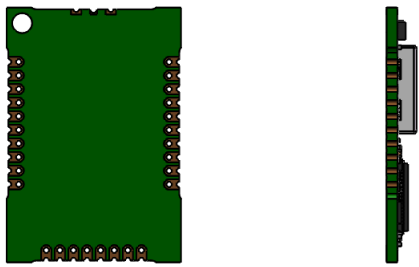
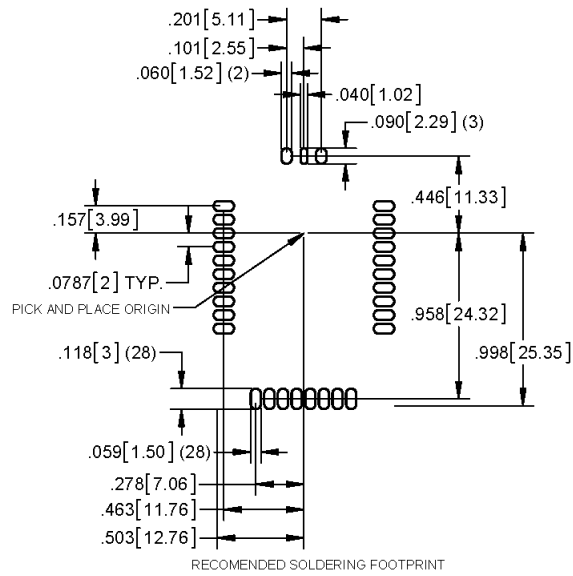
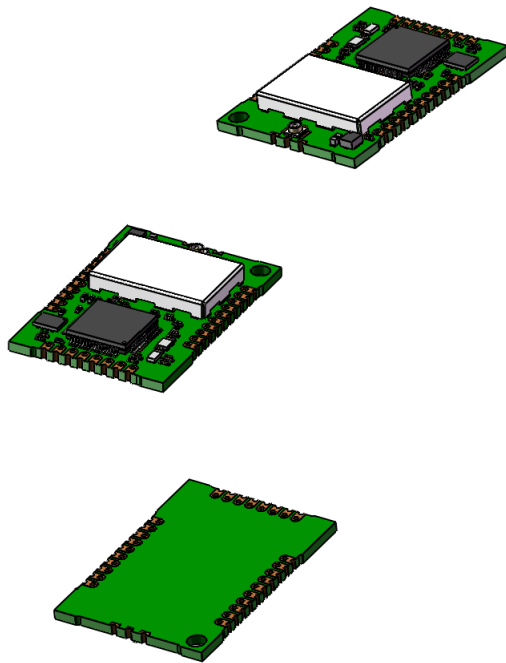

MTDOT-868-M1-UFL
MTDOT-915-M1-UFL

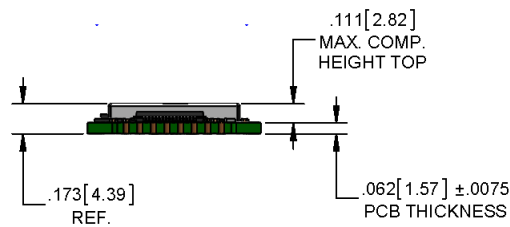

DIMENSIONS IN In [mm]

MTDOT-xxx-M1-TRC

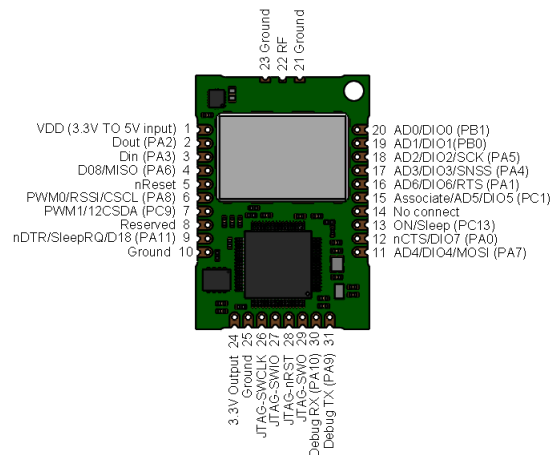
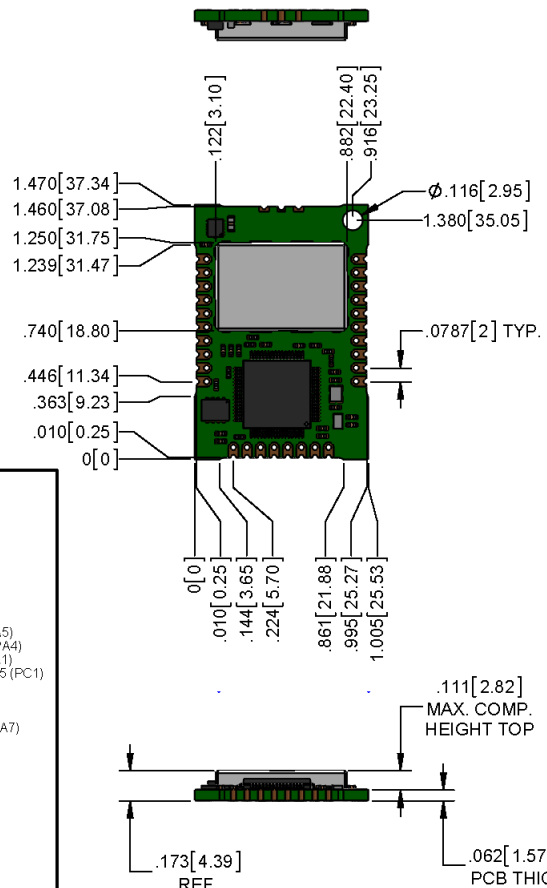
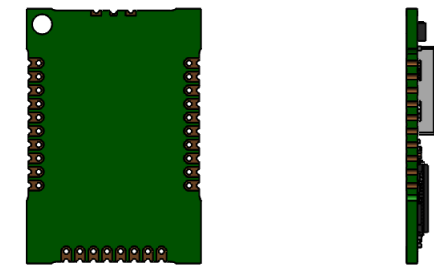
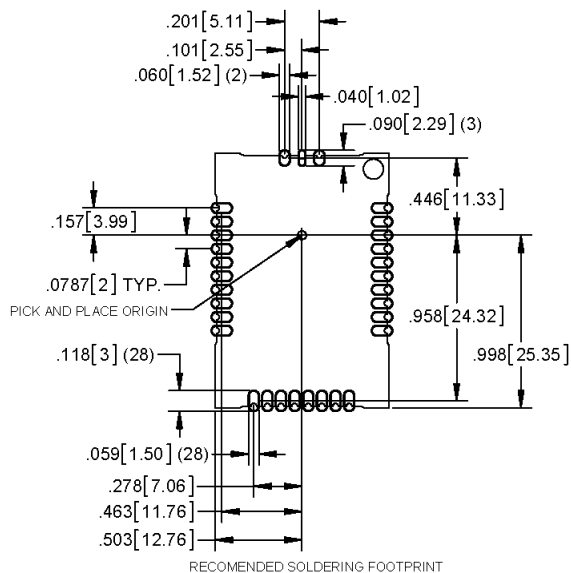
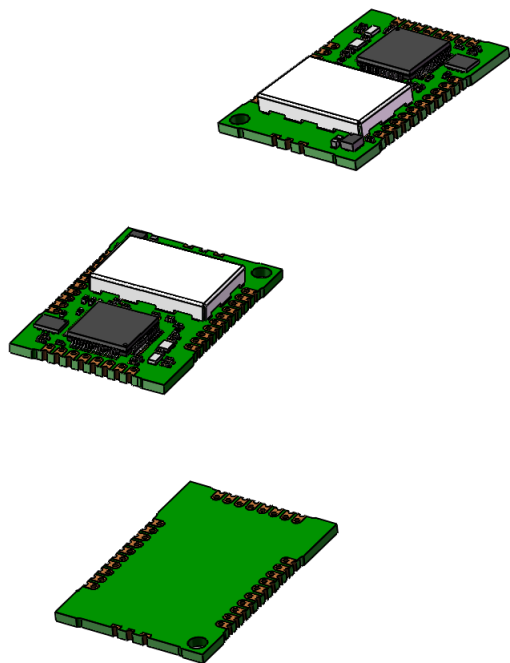

DIMENSIONS IN In [mm]

Chapter 3 – Specifications and Pin Information

MTDOT Specifications

Category	Description
General	
Compatibility	LoRaWAN 1.0.1 specifications
Interfaces	Note that pin functions are multiplexed.
	Up to 21 digital I/O
	Up to 11 analog inputs
	SPI
	I2C
	UART (RX, TX, RTS, CTS)
CPU Performance	
CPU	STM32
Max Clock	96 MHz
Flash Memory	512 KB (400 KB available)
RAM	128 KB
Radio Frequency	
ISM Bands	EU 863 MHz - 868 MHz, NAM 902 MHz - 928 MHz, AU 915 MHz - 928 MHz
Physical Description	
Weight ¹	0.2 oz. (5g)
Dimensions	Refer to Mechanical Drawings for Dimensions.
RF Connectors	
SMA Models	SMA
UFL Models	U.FL
Trace Models	Trace Connection
Environment	
Operating Temperature	-40° C to +85° C
Storage Temperature	-40° C to +85° C
Humidity	20%-90% RH, non-condensing
Power Requirements	
Operating Voltage	3.3 V to 5 V (See Important note regarding voltage)

Category	Description
Certifications and Compliance	
EMC Compliance	EN 300 220-2 V2.4.1:2012
	EN 301 489-03 V1.6.1:2013
Radio Compliance	FCC 15.247:2015
	FCC 15.109:2015
	FCC 15.107:2015
	RSS 247:2015
	ICES-003:2012
	CISPR 22:2008
	EN 300 220-2 V2.4.1:2012
Safety Compliance	UL 60950-1 2nd ED
	cUL 60950-1 2nd ED
	IEC 60950-1 2nd ED AM1 + AM2
	AS/NZS 60950.1

¹Weight is for the MTDOT-xxx-X1P-SMA, which is the heaviest model.

Important:

The MTDOT requires 3.3 V minimum power to maintain certification and to help protect the SPI Flash file system. The onboard LDO regulator output is 3 V derived from the 3.3 V to 5 V (+-5%) input voltage. Starting with firmware version 2.0.16, SPI flash access is prevented if the onboard LDO regulator output drops below 3 V. This code change protects the SPI file system from corruption that could occur from power drop or loss.

Category	Description	
Transmission²		
	North America/Australia	EMEA
Max Transmitter Power Output (TPO)	19 dBm	14 dBm
Maximum Receive Sensitivity	-137 dBm	-137 dBm
Link Budget ³	147 dB Point-to-Point	147 dB Point-to-Point
Max Effective Isotropic Radiated Power (EIRP)	22 dBm	10 dBm

Category	Description	
Receive Sensitivity		
Spreading Factor	North America/Australia Typical Sensitivity ⁴	EMEA Typical Sensitivity ⁵
7	-116 dBm	-124 dBm
8	-119 dBm	-127 dBm
9	-122 dBm	-130 dBm
10	-125 dBm	-133 dBm
11	Not Applicable	-135 dBm
12	Not Applicable	-137 dBm

²Using the Pulse Electronics W1063 antenna, described in the *Chapter 4, Antennas*.

³Greater link budget is possible with higher gain antenna.

⁴RFS_L500: RF sensitivity, Long-Range Mode, highest LNA gain, LNA boost, 500 kHz bandwidth using split Rx/Tx path.

⁵RFS_L125: RF sensitivity, Long-Range Mode, highest LNA gain, LNA boost, 125 kHz bandwidth using split Rx/Tx path.

²Using the Pulse Electronics W1063 antenna, described in the *Chapter 4, Antennas*.

³Greater link budget is possible with higher gain antenna.

⁴RFS_L500: RF sensitivity, Long-Range Mode, highest LNA gain, LNA boost, 500 kHz bandwidth using split Rx/Tx path.

⁵RFS_L125: RF sensitivity, Long-Range Mode, highest LNA gain, LNA boost, 125 kHz bandwidth using split Rx/Tx path.

LoRa Transmission Output Power

868 Models

Max output 25 dBm

Power	Frequency	On Power-up (dBm)	18 Hours After Power-up (dBm)	Bandwidth
27	869.525 MHz	24.18	25	125 kHz
27	869.525 MHz	24.18	24.83	250 kHz

915 Models

Max output 27 dBm

Power	Frequency	On Power-up (dBm)	18 Hours After Power-up (dBm)	Bandwidth
26	923.3 MHz	26.58	25.88	500 kHz
26	925.1 MHz	26.76	26.34	500 kHz
26	927.5 MHz	27.22	26.8	500 kHz

Battery Draw Down

mDot battery life depends on many variables, including transmit power, data rate, sleep usage, and duty cycle. The following figure represents the current consumption in one possible application.

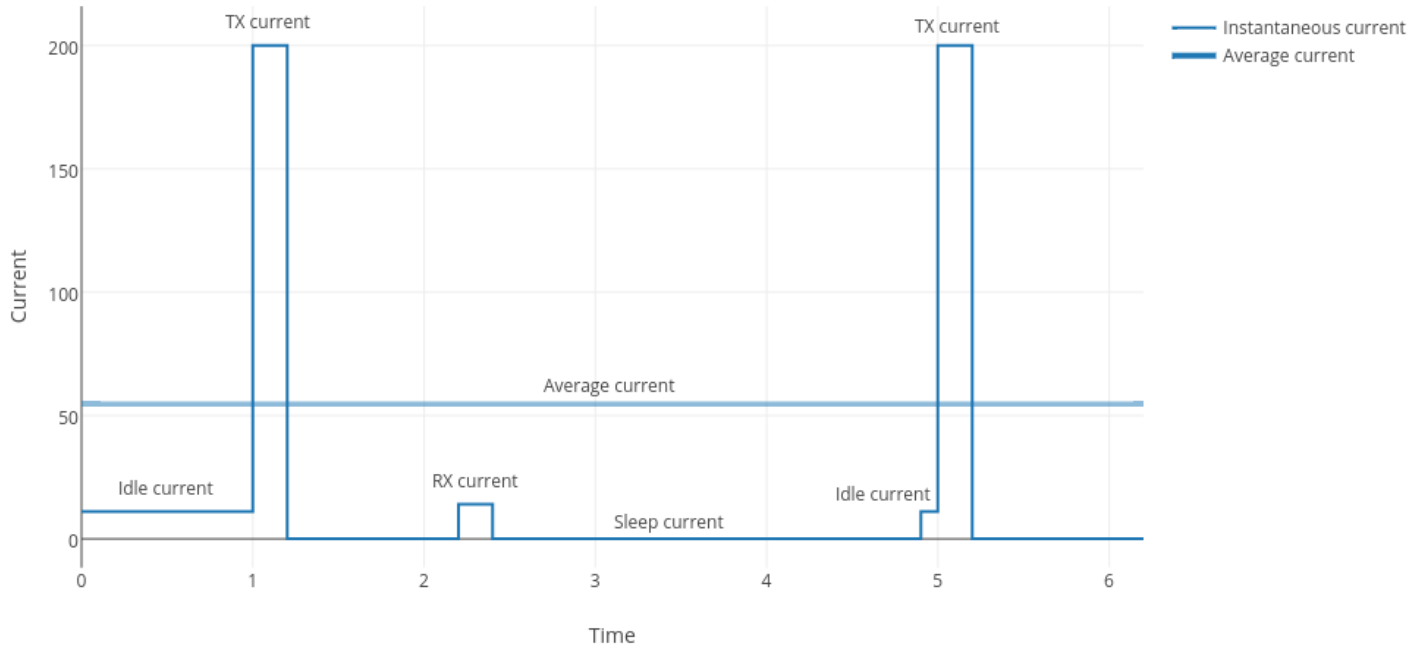

Use the current consumption values from the following Electrical Characteristics table when calculating average power consumption.

Electrical and Timing Characteristics

Note:

- All measurements taken at VDD = 3.3 V and 25 degrees Celsius ambient temperature unless otherwise specified.
- Refer to the ST Micro STM32F411RE datasheet for more detailed processor IO characteristics.
- The STM32F411RE and other onboard ICs are powered by an internal 3.0V voltage regulator.

Signal	Description	Conditions	Min	Typical	Max	Units
VCC	Operating Voltage		3.3	--	5	V
Vin Low	IO input low level		--	--	0.9	V
Vin High	IO input high level		2.1	--	--	V
Vout Low	IO output low level	Pin current = 8mA	--	--	0.4	V
Vout High	IO output high level	3.3V < VDD < 5V	2.4	--	--	V
Vout Low	IO output low level	Pin current = 20mA	--	--	1.3	V
Vout High	IO output high level	3.3V < VDD < 5V	1.7	--	--	V
ICC		Idle mode (no TX, no RX), processor active	--	32	--	mA
		TX, TXP=2	--	34	--	mA
		TX, TXP=11	--	73	--	mA
		TX, TXP=20	--	130	--	mA
		Maximum supply current. Transmitting at TXP=20, all peripherals active, no load on IO pins. VDD = 3.3V. 25 degC ambient temperature.	--	--	250	mA
		Sleep mode	--	40	--	uA
		Deep sleep mode	--	40	--	uA
		RX	--	43	--	mA
T _{NRESET}	NRESET minimum pulse duration	--	1	--	--	ms
V _{NRESET} Low	NRESET input low level	--	--	--	0.9	V
V _{NRESET} High	NRESET input high level	Note: The mDot has an internal pull-up resistor.	2.1	--	--	V

Pin Information

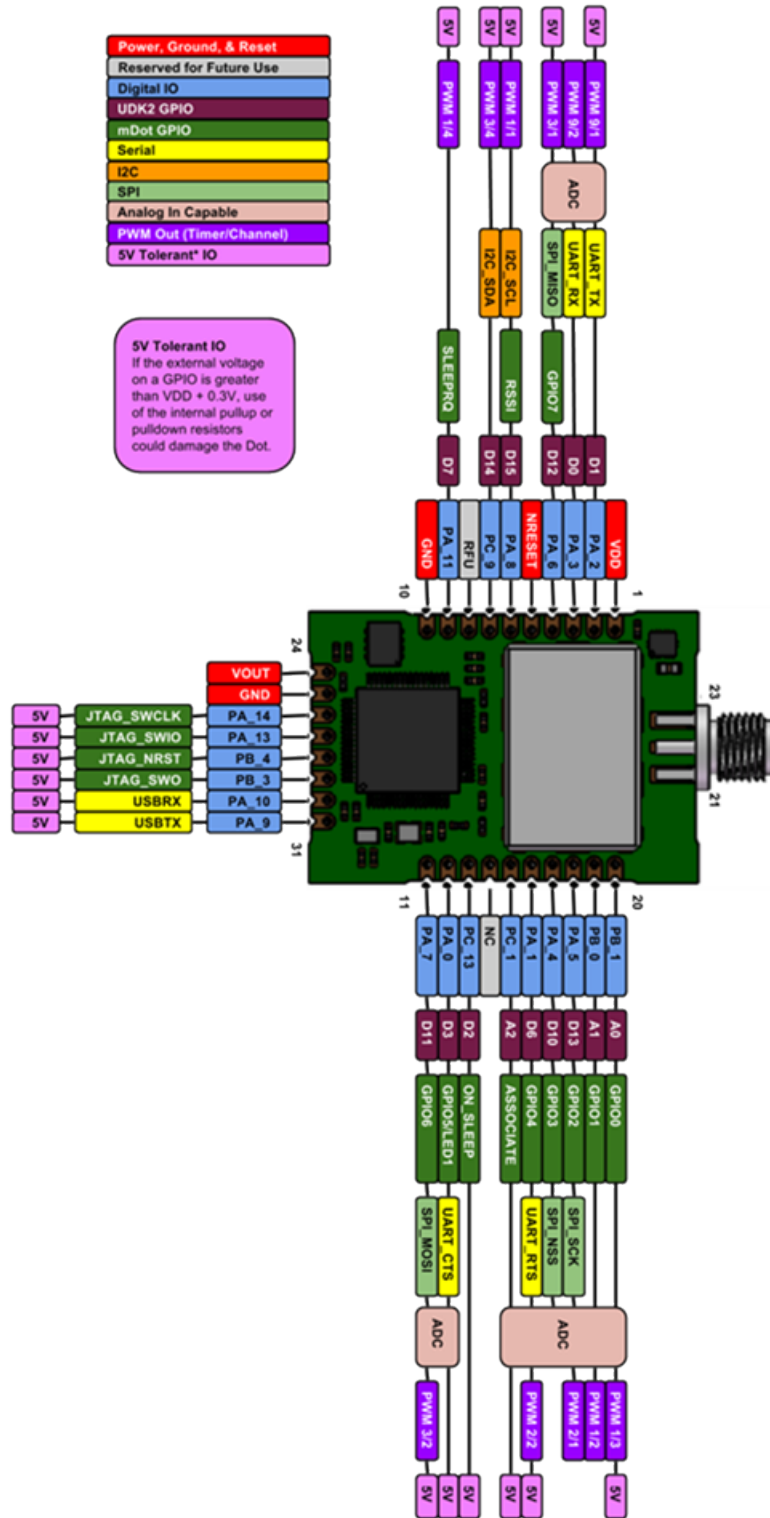

Note: Using the mbed platform with the Cortex-M4 processor expands your pin functionality options.

mDot Pin	STM32411 (Where applicable)	SW Name	Notes
1			3.3 V to 5 V input
2	PA2	UART_TX	GPIO
3	PA3	UART_RX	GPIO
4	PA6	SPI1_MISO	
5	NRST	Reset	nReset input
6	PA8	I2C_SCL	I2C clock
7	PC9	I2C_SDA	I2C Serial data
8	PA12		GPIO
9	PA11	SLEEPREQ	GPIO
10	VSSA/VSS_3/VSS_4		Ground for VCC
11	PA7	SPI1_MOSI	
12	PA0-WKUP	GPIO5	Wake up from low power modes on rising edge
13	PC13	ON_SLEEP	Sleep On
14	No Connect		Not routed on board
15	PC1	ASSOCIATE	GPIO
16	PA1	GPIO4	GPIO
17	PA4	SPI1_CS	
18	PA5	SPI1_SCK	
19	PB0	GPIO1	
20	PB1	GPIO0	
24	VDDA		3V @25ma reference voltage
25	VSSA/VSS_3/VSS_4		Ground
26	PA14	JTMS-SWCLK	STMicro - JTAG Clock /Serial Wire Debug Clock
27	PA13	JTMS-SWIO	STMicro - JTAG Data I/O /Serial Wire Debug Data
28	PB4	JTMS-nRst	STMicro - JTAG reset
29	PB3	JTDO-SO	STMicro - SWO - Trace View
30	PA10	USB_RX	Debug RX routes to USB on developer board
31	PA9	USB_TX	Debug TX routes to USB on developer board

SPI Flash

Note: Using the SPI Flash, Micron M25P16 Family.

Pin	Function	Description
PC_12	SPI3_MOSI	SPI serial data
PC_11	SPI3_MISO	SPI serial data
PC_10	SPI3_SCK	SPI clock
PC_6	SPI3_CS	SPI chip select
PC_7	FLASH_HOLD#	Use the HOLD# signal to pause any serial communications with the device without deselecting the device
PC_8	FLASH_WP#	Flash write protect

Pull-Up/Down

mDot Pin	Pin Name	SW Name	PU/PD
5	NRST	NRESET	10K PU
	PB12	LORA_NSS	100K PU
	PC6	SPI3_NCS	10K PU
	P88	Flash_WPn	10K PD
	PB4	NRESET	10K PU

LoRa

Pin	Function
PC_0	LORA_RESET
PC_2	LORA_RXCTL
PC_3	LORA_TXCTL
PB_5	LORA_DIO0
PB_6	LORA_DIO1
PB_7	LORA_DIO2
PB_8	LORA_DIO3
PB_9	LORA_DIO4
PB_10	LORA_DIO5
LoRa/SPI2	
PB_12	LORA_NSS
PB_13	LORA_RXCTL
PB_14	LORA_MISO
PB_15	LORA_MOSI

Crystals/Oscillator

Pin	Description
PC14	Real-time clock
PC15	Real-time clock
PH0-OSC_IN	High speed system clock
PH1-OSC_OUT	High speed system clock

Route Pads

For U.FL models, use the U.FL connector or route pads as follows. These are also available on trace models.

Pads	Function	Description
21	GND	RF Ground for antenna
22		RF Antenna In/Out
23	GND	RF Ground for antenna

mDot Pinout Design Notes

Refer to the mechanical drawing for your model for pin locations.

- All pins that go to connectors are directly connected to the processor.
- Reset is the only pin with pull up.
- I/O is 5V tolerant.

mDots allow you to program pins depending on your application:

- **Serial:** Available out of the box. See Serial Pinout Notes for details.
- **mbed:** Designed with the mbed STM32F411 RET 64-pin processor, this option provides the most flexibility. For more information about processor capabilities, see the STM32F411 RET datasheet.

Note: To program the mDot, you need an mDot model with programming header., model MTDOT-xx-X1P-SMA

Serial Pinout Notes

Out of the box, these pins are available for serial applications. Refer to the mechanical drawing for your model for pin locations.

- 2 Dout/TX
- 3 Din/RX
- 9 DTR
- 12 CTS
- 13 On/Sleep
- 16 RTS

Serial Settings

When creating a serial connection with the device on the developer board, connect a serial cable to the DB-9 connector, open communications software (such as TeraTerm, Putty, or Minicom), and use the following settings:

- Baud rate = 115,200
- Data bits = 8
- Parity = N
- Stop bits = 1
- Flow control = Off

LoRa

Throughput Rates

Theoretical maximum speeds for LoRa mode with ACKs off are:

- Using spreading factor 7 at 125kHz, the throughput rate is 5470 bps (5.47 kbps).
- Using spreading factor 7 at 500kHz the receiving throughput rate is 21900 bps (21.9 kbps).

Note: Data rates in the LoRaWAN specification vary by geographic region.

Range

Variables effecting the range include TX power, antenna gain, RX sensitivity, fade margin, earth's curvature. Use the following formula to calculate the maximum range:

$$Range_{Miles} = 10^{\left(\frac{TxPower + Antenna\ gain\ total - RX\ Sensitivity - Fade\ Margin - 36.56}{20} - LOG_{10}(F_{MHz})\right)}$$

The following table provides example settings and the theoretical maximum range based on these settings.

Example	18dB Transmit Power for 915 MHz Models	Units	Example 14dB Transmit Power for 868MHz Models
Frequency	915	MHz	868
TX Power	19	dBm	14
TX Antenna Gain	3	dB	3
RX Sensitivity ¹	-120	dBm	-120
RX Antenna Gain	3	dB	3
Fade Margin ²	30	dB	30
Distance	8.14	Miles	5.41
Distance	13.08	Km	8.70

¹RX Sensitivity is set to a conservative -120dBm, but can vary from -117 to -137dBm.

²Fade Margin is set at the worst case of 30dB. Fade margin is an allowance a system designer includes to account for unknown variables. The higher the fade margin, the better the overall link quality will be. With a fade margin set to zero, the link budget is still valid, but only in LOS conditions, which is not practical for most designs. The amount of fade margin to include in a calculation depends on the environment in which you will deploy the system. A fade margin of 12 dBm is good, but a better number would be 20 to 30 dBm.

Resetting the mDot

To reset the mDot

1. Drive the RESET signal low for at least T_{NRESET} .
2. Select either:
 - Allow RESET to float. The internal pull-up resistor pulls it up.
 - Drive the RESET line high.

The processor starts executing code after the RESET line is high.

Chapter 4 – Antennas

Antenna System

The LoRa antenna performance depends on the implementation and antenna design. The integration of the antenna system into the product is a critical part of the design process; therefore, it is essential to consider it early so the performance is not compromised. If changes are made to the device's certified antenna system, then recertification will be required.

This radio transmitter has been approved with the antenna types listed below. The antenna used must maintain the same specifications. The antenna must be of the same type, with similar in-band and out-of-band radiation patterns. Antenna types not included on this list, or having a greater gain than the maximum gain indicated for the listed type, are strictly prohibited for use with this device.

U.FL and Trace Antenna Options

Currently, FCC approval includes Pulse Electronics SMA antenna only. If using U.FL or trace antennas, note the following:

- **For a simple trace to RF antennas:** Routing must follow standard RF design rules and practices for stripline/microstrip for a 50 ohm impedance line. Use the developer board schematics for a reference circuit for the a trace antenna. This option may require additional certification testing.
- **For U.FL antennas:** The antenna and cable combination in your design cannot exceed the performance of the SMA antenna as listed in the next topic.

Pulse Electronics Antenna

Manufacturer:	Pulse Electronics
Description:	868-915 MHz RP-SMA Antenna, 8"
Model Number:	W1063
MultiTech Part Number:	45009830L

MultiTech ordering information:

Ordering Part Number	Quantity
AN868-915A-1HRA	1
AN868-915A-10HRA	10
AN868-915A-50HRA	50

Antenna Specifications

Category	Description
Frequency Range	868-928 MHz
Impedance	50 Ohms
VSWR	≤ 2.0

Category	Description
Gain	3.0 dBi
Radiation	Omni
Polarization	Vertical

OEM Integration

FCC & IC Information to Consumers

The user manual for the consumer must contain the statements required by the following FCC and IC regulations: 47 C.F.R. 15.19(a)(3), 15.21, 15.105 and RSS-Gen Issue 3, Dec 2010; 7.1.2 and 7.1.3

FCC Grant Notes

The OEM should follow all the grant notes listed below. Otherwise, further testing and device approvals may be necessary.

FCC Definitions

Portable: (§2.1093) — A portable device is defined as a transmitting device designed to be used so that the radiating structure(s) of the device is/are within 20 centimeters of the body of the user.

Mobile: (§2.1091) — A mobile device is defined as a transmitting device designed to be used in other than fixed locations and to generally be used in such a way that a separation distance of at least 20 centimeters is normally maintained between the transmitter's radiating structure(s) and the body of the user or nearby persons.

Actual content pending Grant: *This device is a mobile device with respect to RF exposure compliance. The antenna(s) used for this transmitter must be installed to provide a separation distance of at least 20 cm from all persons, and must not be collocated or operate in conjunction with any other antenna or transmitter except in accordance with FCC multi-transmitter product guidelines. Installers and end-users must be provided with specific information required to satisfy RF exposure compliance for installations and final host devices. (See note under Grant Limitations.) Compliance of this device in all final host configurations is the responsibility of the Grantee.*

Note: Host design configurations constituting a device for portable use (<20 cm from human body) require separate FCC/IC approval.

Host Labeling

The following statements are required to be on the host label:

This device contains FCC ID: {Add the FCC ID of the specific device}

This device contains equipment certified under IC ID: {Add the IC ID of the specific device}

For additional labeling requirements, see the product's Labeling Requirements. For the FCC and IC IDs, see specific certificate information in the Regulatory Statement chapter.

Chapter 5 – Safety Information

Handling Precautions

To avoid damage due to the accumulation of static charge, use proper precautions when handling any cellular device. Although input protection circuitry has been incorporated into the devices to minimize the effect of static build-up, use proper precautions to avoid exposure to electronic discharge during handling and mounting the device.

Radio Frequency (RF) Safety

Due to the possibility of radio frequency (RF) interference, it is important that you follow any special regulations regarding the use of radio equipment. Follow the safety advice given below.

- Operating your device close to other electronic equipment may cause interference if the equipment is inadequately protected. Observe any warning signs and manufacturers' recommendations.
- Different industries and businesses restrict the use of cellular devices. Respect restrictions on the use of radio equipment in fuel depots, chemical plants, or where blasting operations are in process. Follow restrictions for any environment where you operate the device.
- Do not place the antenna outdoors.
- Switch OFF your wireless device when in an aircraft. Using portable electronic devices in an aircraft may endanger aircraft operation, disrupt the cellular network, and is illegal. Failing to observe this restriction may lead to suspension or denial of cellular services to the offender, legal action, or both.
- Switch OFF your wireless device when around gasoline or diesel-fuel pumps and before filling your vehicle with fuel.
- Switch OFF your wireless device in hospitals and any other place where medical equipment may be in use.

Sécurité relative aux appareils à radiofréquence (RF)

À cause du risque d'interférences de radiofréquence (RF), il est important de respecter toutes les réglementations spéciales relatives aux équipements radio. Suivez les conseils de sécurité ci-dessous.

- Utiliser l'appareil à proximité d'autres équipements électroniques peut causer des interférences si les équipements ne sont pas bien protégés. Respectez tous les panneaux d'avertissement et les recommandations du fabricant.
- Certains secteurs industriels et certaines entreprises limitent l'utilisation des appareils cellulaires. Respectez ces restrictions relatives aux équipements radio dans les dépôts de carburant, dans les usines de produits chimiques, ou dans les zones où des dynamitages sont en cours. Suivez les restrictions relatives à chaque type d'environnement où vous utiliserez l'appareil.
- Ne placez pas l'antenne en extérieur.
- Éteignez votre appareil sans fil dans les avions. L'utilisation d'appareils électroniques portables en avion est illégale: elle peut fortement perturber le fonctionnement de l'appareil et désactiver le réseau cellulaire. S'il ne respecte pas cette consigne, le responsable peut voir son accès aux services cellulaires suspendu ou interdit, peut être poursuivi en justice, ou les deux.
- Éteignez votre appareil sans fil à proximité des pompes à essence ou de diesel avant de remplir le réservoir de votre véhicule de carburant.

- Éteignez votre appareil sans fil dans les hôpitaux ou dans toutes les zones où des appareils médicaux sont susceptibles d'être utilisés.

Interference with Pacemakers and Other Medical Devices

Potential interference

Radio frequency energy (RF) from cellular devices can interact with some electronic devices. This is electromagnetic interference (EMI). The FDA helped develop a detailed test method to measure EMI of implanted cardiac pacemakers and defibrillators from cellular devices. This test method is part of the Association for the Advancement of Medical Instrumentation (AAMI) standard. This standard allows manufacturers to ensure that cardiac pacemakers and defibrillators are safe from cellular device EMI.

The FDA continues to monitor cellular devices for interactions with other medical devices. If harmful interference occurs, the FDA will assess the interference and work to resolve the problem.

Precautions for pacemaker wearers

If EMI occurs, it could affect a pacemaker in one of three ways:

- Stop the pacemaker from delivering the stimulating pulses that regulate the heart's rhythm.
- Cause the pacemaker to deliver the pulses irregularly.
- Cause the pacemaker to ignore the heart's own rhythm and deliver pulses at a fixed rate.

Based on current research, cellular devices do not pose a significant health problem for most pacemaker wearers. However, people with pacemakers may want to take simple precautions to be sure that their device doesn't cause a problem.

- Keep the device on the opposite side of the body from the pacemaker to add extra distance between the pacemaker and the device.
- Avoid placing a turned-on device next to the pacemaker (for example, don't carry the device in a shirt or jacket pocket directly over the pacemaker).

Device Maintenance

When maintaining your device:

- Do not attempt to disassemble the device. There are no user serviceable parts inside.
- Do not misuse the device. Follow instructions on proper operation and only use as intended. Misuse could make the device inoperable, damage the device and/or other equipment, or harm users.
- Do not apply excessive pressure or place unnecessary weight on the device. This could result in damage to the device or harm to users .
- Do not use this device in explosive or hazardous environments unless the model is specifically approved for such use. The device may cause sparks. Sparks in explosive areas could cause explosion or fire and may result in property damage, severe injury, and/or death.
- Do not expose your device to any extreme environment where the temperature or humidity is high. Such exposure could result in damage to the device or fire.
- Do not expose the device to water, rain, or spilled beverages. It is not waterproof. Exposure to liquids could result in damage to the device.

- Do not place the device alongside computer discs, credit or travel cards, or other magnetic media. The information contained on discs or cards may be affected by the device.
- Using accessories, such as antennas, that MultiTech has not authorized or that are not compliant with MultiTech's accessory specifications may invalidate the warranty.

If the device is not working properly, contact MultiTech Technical Support.

User Responsibility

Respect all local regulations for operating your wireless device. Use the security features to block unauthorized use and theft.

Chapter 6 – Regulatory Information

EMC, Safety, and Radio Equipment Directive (RED) Compliance



The CE mark is affixed to this product to confirm compliance with the following European Community Directives:

Council Directive 2011/65/EU on the restriction of the use of certain hazardous substances in electrical and electronic equipment;

and

Council Directive 2014/53/EU on radio equipment and telecommunications terminal equipment and the mutual recognition of their conformity.

MultiTech declares that this device is in compliance with the essential requirements and other relevant provisions of Directive 2014/53/EU. The declaration of conformity may be requested at <https://support.multitech.com>.

47 CFR Part 15 Regulation Class B Devices

This equipment has been tested and found to comply with the limits for a Class B digital device, pursuant to part 15 of the FCC Rules. These limits are designed to provide reasonable protection against harmful interference in a residential installation. This equipment generates, uses, and can radiate radio frequency energy and, if not installed and used in accordance with the instructions, may cause harmful interference to radio communications. However, there is no guarantee that interference will not occur in a particular installation. If this equipment does cause harmful interference to radio or television reception, which can be determined by turning the equipment off and on, the user is encouraged to try to correct the interference by one or more of the following measures:

- Reorient or relocate the receiving antenna.
- Increase the separation between the equipment and receiver.
- Connect the equipment into an outlet on a circuit different from that to which the receiver is connected.
- Consult the dealer or an experienced radio/TV technician for help.

Warning: Changes or modifications to this unit not expressly approved by the party responsible for compliance could void the user's authority to operate the equipment.

FCC Interference Notice

Per FCC 15.19(a)(3) and (a)(4) This device complies with part 15 of the FCC Rules. Operation is subject to the following two conditions: (1) This device may not cause harmful interference, and (2) this device must accept any interference received, including interference that may cause undesired operation.

FCC Grant

FCC Part 15

FCC Identifier:	AU792U13A16857
Equipment Class:	Digital Transmission System
Notes:	MTDOT-915
FCC Rule Parts:	15C
Approval:	Single Modular
Frequency Range:	902.3-914.9
Output Watts:	0.0772

Output power is conducted. This transmitter is a hybrid per FCC 15.247(f) and FCC KDB 453039. The antenna(s) used for this transmitter must be installed to provide a separation distance of at least 20 cm from all persons and must not be collocated or operating in conjunction with any other antenna or transmitter within a host device, except in accordance with FCC multi-transmitter product procedures. End-users and installers must be provided with antenna installation instructions and transmitter operating conditions for satisfying RF exposure compliance.

FCC Notice

MTDOT-x products are open development based products that contain a sub ghz radio technology. MultiTech has certified for compliance with US and Foreign compliance bodies including FCC, R&TTE and others. (e.g. FCC 15.247:2015 & IC RSS-210:2010)

MultiTech provides software code meant to operate the radio to a level that maintains compliance with the operating modes under which these radio devices were certified. To ensure this level of compliance, the software code is provided in binary form only. Users are prohibited from making any changes that affect the operation of the radio performance. Accessing or controlling the radio through any means other than the provided binary software will require the user to obtain their own intentional radiator license from the certification body governing their locality, as all pre-certification provided with mDot will have been made invalid.

Industry Canada Class B Notice

This Class B digital apparatus meets all requirements of the Canadian Interference-Causing Equipment Regulations.

Cet appareil numérique de la classe B respecte toutes les exigences du Règlement Canadien sur le matériel brouilleur.

This device complies with Industry Canada license-exempt RSS standard(s). The operation is permitted for the following two conditions:

1. the device may not cause interference, and
2. this device must accept any interference, including interference that may cause undesired operation of the device.

Le présent appareil est conforme aux CNR d'Industrie Canada applicables aux appareils radio exempts de licence. L'exploitation est autorisée aux deux conditions suivantes:

1. l'appareil ne doit pas produire de brouillage, et

2. l'appareil doit accepter tout brouillage radioélectrique subi, même si le brouillage est susceptible d'en compromettre le fonctionnement.

Industry Canada

Certification Number/No. de Certification	125A-0054
Type of Radio Equipment/Genre de Matériel	Spread Spectrum/Digital Device (902-928MHz)/ Modular Approval/Approbation modulaire
Model/Modèle	MTDOT-915

Specification/ Cahier des Charges	Issue/ Édition	From Frequency/ De Fréquences	To Frequency/ À Fréquences	Emmission Designation/ Designation D'émission	Minimum Power	Maximum Power
RSS247	1.0	902.3 MHz	914.9 MHz	GXDXX	77.2 mW	77.2 mW

Certification of equipment means only that the equipment has met the requirements of the above noted specification. License applications, where applicable to use certified equipment, are acted on accordingly by the Industry Canada issuing office and will depend on the existing radio environment, service and location of operation. This certificate is issued on condition that the holder complies and will continue to comply with the requirements and procedures issued by Industry Canada. The equipment for which this certificate is issued shall not be manufactured, imported distributed, leased, offered for sale or sold unless the equipment complies with the applicable technical specifications and procedures issued by Industry Canada.

La certification du matériel signifie seulement que le matériel a satisfait aux exigences de la norme indiquée ci-dessus. Les demandes de licences nécessaires pour l'utilisation du matériel certifié sont traitées en conséquence par le bureau de délivrance d'Industrie Canada et dépendent des conditions radio ambiantes, du service et de l'emplacement d'exploitation. Le présent certificat est délivré à la condition que le titulaire satisfasse et continue de satisfaire aux exigences et aux procédures d'Industrie Canada. Le matériel à l'égard duquel le présent certificat est délivré ne doit pas être fabriqué, importé, distribué, loué, mis en vente ou vendu à moins d'être conforme aux procédures et aux spécifications techniques applicable publiées par Industrie Canada.

Chapter 7 – Environmental Notices

Waste Electrical and Electronic Equipment Statement

Note: This statement may be used in documentation for your final product applications.

WEEE Directive

The WEEE Directive places an obligation on EU-based manufacturers, distributors, retailers, and importers to take-back electronics products at the end of their useful life. A sister directive, ROHS (Restriction of Hazardous Substances) complements the WEEE Directive by banning the presence of specific hazardous substances in the products at the design phase. The WEEE Directive covers all MultiTech products imported into the EU as of August 13, 2005. EU-based manufacturers, distributors, retailers and importers are obliged to finance the costs of recovery from municipal collection points, reuse, and recycling of specified percentages per the WEEE requirements.

Instructions for Disposal of WEEE by Users in the European Union

The symbol shown below is on the product or on its packaging, which indicates that this product must not be disposed of with other waste. Instead, it is the user's responsibility to dispose of their waste equipment by handing it over to a designated collection point for the recycling of waste electrical and electronic equipment. The separate collection and recycling of your waste equipment at the time of disposal will help to conserve natural resources and ensure that it is recycled in a manner that protects human health and the environment. For more information about where you can drop off your waste equipment for recycling, please contact your local city office, your household waste disposal service or where you purchased the product.

July, 2005



REACH Statement

Registration of Substances

After careful review of the legislation and specifically the definition of an “article” as defined in EC Regulation 1907/2006, Title II, Chapter 1, Article 7.1(a)(b), it is our current view that Multi-Tech Systems, Inc. products would be considered as “articles.” In light of the definition in § 7.1(b) which requires registration of an article only if it contains a regulated substance that “is intended to be released under normal or reasonably foreseeable conditions of use,” our analysis is that Multi-Tech Systems, Inc. products constitute nonregisterable articles for their intended and anticipated use.

Substances of Very High Concern (SVHC)

Per the candidate list of Substances of Very High Concern (SVHC) published October 28, 2008 we have reviewed these substances and certify the Multi-Tech Systems, Inc. products are compliant per the EU “REACH” requirements of less than 0.1% (w/w) for each substance. If new SVHC candidates are published by the European Chemicals Agency, and relevant substances have been confirmed to be greater than 0.1% (w/w), Multi-Tech Systems, Inc. will provide updated compliance status.

Multi-Tech Systems, Inc. also declares it has been duly diligent in ensuring that the products supplied are compliant through a formalized process which includes collection and validation of materials declarations and selective materials analysis where appropriate. This data is controlled as part of a formal quality system and will be made available upon request.

Restriction of the Use of Hazardous Substances (RoHS)



Multi-Tech Systems, Inc.

Certificate of Compliance

2011/65/EU

Multi-Tech Systems, Inc. confirms that its embedded products comply with the chemical concentration limitations set forth in the directive 2011/65/EU of the European Parliament (Restriction of the use of certain Hazardous Substances in electrical and electronic equipment - RoHS).

These MultiTech products do not contain the following banned chemicals¹:

- Lead, [Pb] < 1000 PPM
- Mercury, [Hg] < 1000 PPM
- Hexavalent Chromium, [Cr+6] < 1000 PPM
- Cadmium, [Cd] < 100 PPM
- Polybrominated Biphenyl, [PBB] < 1000 PPM
- Polybrominated Diphenyl Ether, [PBDE] < 1000 PPM

Environmental considerations:

- Moisture Sensitivity Level (MSL) =1
- Maximum Soldering temperature = 260C (in SMT reflow oven)

¹Lead usage in some components is exempted by the following RoHS annex, therefore higher lead concentration would be found in some modules (>1000 PPM);

- Resistors containing lead in a glass or ceramic matrix compound.

Information on HS/TS Substances According to Chinese Standards

In accordance with China's Administrative Measures on the Control of Pollution Caused by Electronic Information Products (EIP) # 39, also known as China RoHS, the following information is provided regarding the names and concentration levels of Toxic Substances (TS) or Hazardous Substances (HS) which may be contained in Multi-Tech Systems Inc. products relative to the EIP standards set by China's Ministry of Information Industry (MII).

Hazardous/Toxic Substance/Elements

Name of the Component	Lead (PB)	Mercury (Hg)	Cadmium (CD)	Hexavalent Chromium (CR6+)	Polybrominated Biphenyl (PBB)	Polybrominated Diphenyl Ether (PBDE)
Printed Circuit Boards	O	O	O	O	O	O
Resistors	X	O	O	O	O	O
Capacitors	X	O	O	O	O	O
Ferrite Beads	O	O	O	O	O	O
Relays/Opticals	O	O	O	O	O	O
ICs	O	O	O	O	O	O
Diodes/ Transistors	O	O	O	O	O	O
Oscillators and Crystals	X	O	O	O	O	O
Regulator	O	O	O	O	O	O
Voltage Sensor	O	O	O	O	O	O
Transformer	O	O	O	O	O	O
Speaker	O	O	O	O	O	O
Connectors	O	O	O	O	O	O
LEDs	O	O	O	O	O	O
Screws, Nuts, and other Hardware	X	O	O	O	O	O
AC-DC Power Supplies	O	O	O	O	O	O
Software /Documentation CDs	O	O	O	O	O	O
Booklets and Paperwork	O	O	O	O	O	O
Chassis	O	O	O	O	O	O

X Represents that the concentration of such hazardous/toxic substance in all the units of homogeneous material of such component is higher than the SJ/Txxx-2006 Requirements for Concentration Limits.

O Represents that no such substances are used or that the concentration is within the aforementioned limits.

Information on HS/TS Substances According to Chinese Standards (in Chinese)

依照中国标准的有毒有害物质信息

根据中华人民共和国信息产业部 (MII) 制定的电子信息产品 (EIP) 标准—中华人民共和国《电子信息产品污染控制管理办法》(第 39 号), 也称作中国 RoHS, 下表列出了 Multi-Tech Systems, Inc. 产品中可能含有的有毒物质 (TS) 或有害物质 (HS) 的名称及含量水平方面的信息。

有害/有毒物质/元素

成分名称	铅 (PB)	汞 (Hg)	镉 (CD)	六价铬 (CR6+)	多溴联苯 (PBB)	多溴二苯醚 (PBDE)
印刷电路板	O	O	O	O	O	O
电阻器	X	O	O	O	O	O
电容器	X	O	O	O	O	O
铁氧体磁环	O	O	O	O	O	O
继电器/光学部件	O	O	O	O	O	O
ICs	O	O	O	O	O	O
二极管/晶体管	O	O	O	O	O	O
振荡器和晶振	X	O	O	O	O	O
调节器	O	O	O	O	O	O
电压传感器	O	O	O	O	O	O
变压器	O	O	O	O	O	O
扬声器	O	O	O	O	O	O
连接器	O	O	O	O	O	O
LEDs	O	O	O	O	O	O
螺丝、螺母以及其它五金件	X	O	O	O	O	O
交流-直流电源	O	O	O	O	O	O
软件/文档 CD	O	O	O	O	O	O
手册和纸页	O	O	O	O	O	O
底盘	O	O	O	O	O	O

X 表示所有使用类似材料的设备中有害/有毒物质的含量水平高于 SJ/Txxx-2006 限量要求。

O 表示不含该物质或者该物质的含量水平在上述限量要求之内。

Chapter 8 – Labels

Approvals and Certification

In most cases, when integrated and used with an antenna system that was part of the MultiTech modem certification, additional approvals or certifications are not required for the device you develop as long as the following are met.

- **PTCRB Requirements:** The antenna system cannot be altered.
- **Model Identification:** The MultiTech model identification allows the carrier to verify the modem as one of its approved models. This information is located on the modem's label below the bar code.

Example Labels

Note: Actual labels vary depending on the regulatory approval markings and content.

This device complies with part 15 of the FCC Rules. Operation is subject to the following two conditions: (1) This device may not cause harmful interference, and (2) this device must accept any interference received, including interference that may cause undesired operation.

The label shown is not the actual size.

- 1 - MultiTech Model Identification.
- 2 - MultiTech Ordering Part Number.
- 3 - Device Node Number.

Example North America Package Label



North America Device Label



Example EMEA Package Label



EMEA Device Label



Example Australia Package Label

SKU: (1P) **94557162LF** 

1 → **MODEL: MTDOT - 915**
 B/O: - AU - M1 - UFL - 1

2 → **ORDER P/N: MTDOT - 915 - AU - M1 - UFL - 1**
 ORIGIN: (4) US

 Produced in the US of US and non-US components
 915 MHz 3W1 LoRa UFL/FC (1 P)
 AU Channel Plan

MultiConnect® mDot
 Long Range Wireless Module

 **RECYCLABLE**

 **7 89487 35415 116**

 **S/N: (S) 19041318**
S19041318

Australia Device Label

1 → **Model MTDOT - 915**
 B/O - AU - M1 - UFL - 1 **MULTITECH**
 FCC ID AU792U13A16857 www.multitech.com

SKU # 94557162LF
Serial#: 19041318

 **IC 125A - 0054**
DOM 2017 02 08

 **FC** Home or Office Use
E150299

3 →  **NODE: 00 80 00 00 00 00 D7 BB**
 Produced in the US of US and non-US components

Chapter 9 – Developer Kit Overview

Developer Board Overview

MultiTech offers two Developer Kits for prototyping and developing with the mDot:

- **MTUDK2-ST-MDOT** is a scaled down version of the developer board and kit for the mDot.
- **MTMDK-ST-MDOT** is a mini developer board exclusively for the mDot. If using the Micro DK, go to *Chapter 13 Micro Developer Kit* for details on this developer board.

Developer kits help streamline your development efforts and evaluate your products and applications. Easily plug in your communications device and use the developer kit for testing, programming and evaluation.

Note: Developer information in this section applies to using either MTUDK2 developer kit with an mDot; however, the illustrations show the MTUDK2-ST-MDOT model.

Developer Board Features

- USB and serial interfaces
- USB port for mbed development environment
- RS-232 DB-9 connector for serial interface
- Arduino shield socket

MTUDK2-ST-MDOT Developer Kit Contents

The MTUDK2-ST-MDOT Developer Kit includes the following:

Developer Board	1 - MTUDK 2.0 mDot Developer Board
Cables	1 - Micro USB Cable
	1 - RSMA-U.FL Antenna Cables (attached to developer board)
Antennas	1 - 868-945 MHz Antenna
Customer Notices	Quick Start
Additional	One promotional screwdriver

Chapter 10 – Board Components

Developer Board

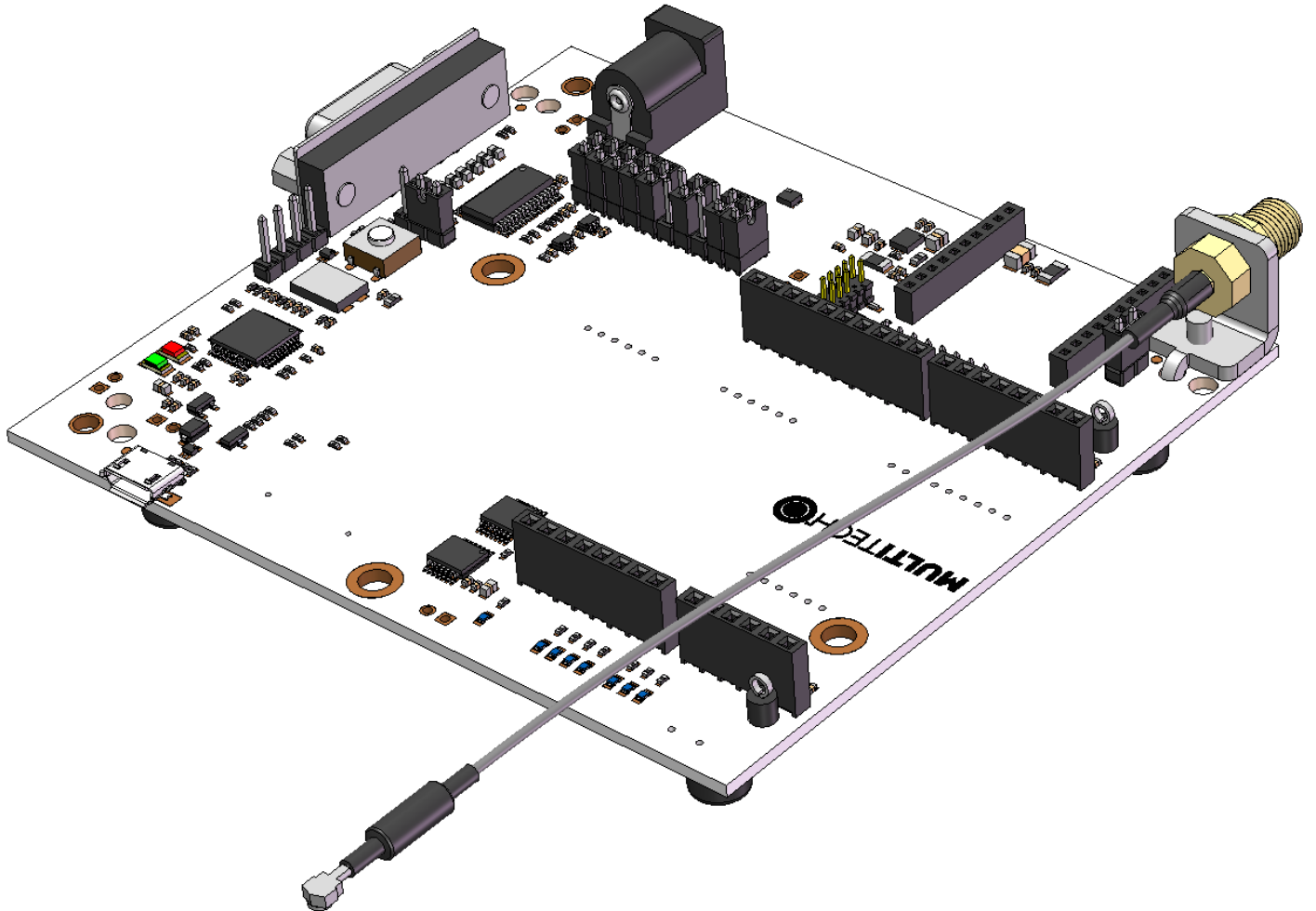

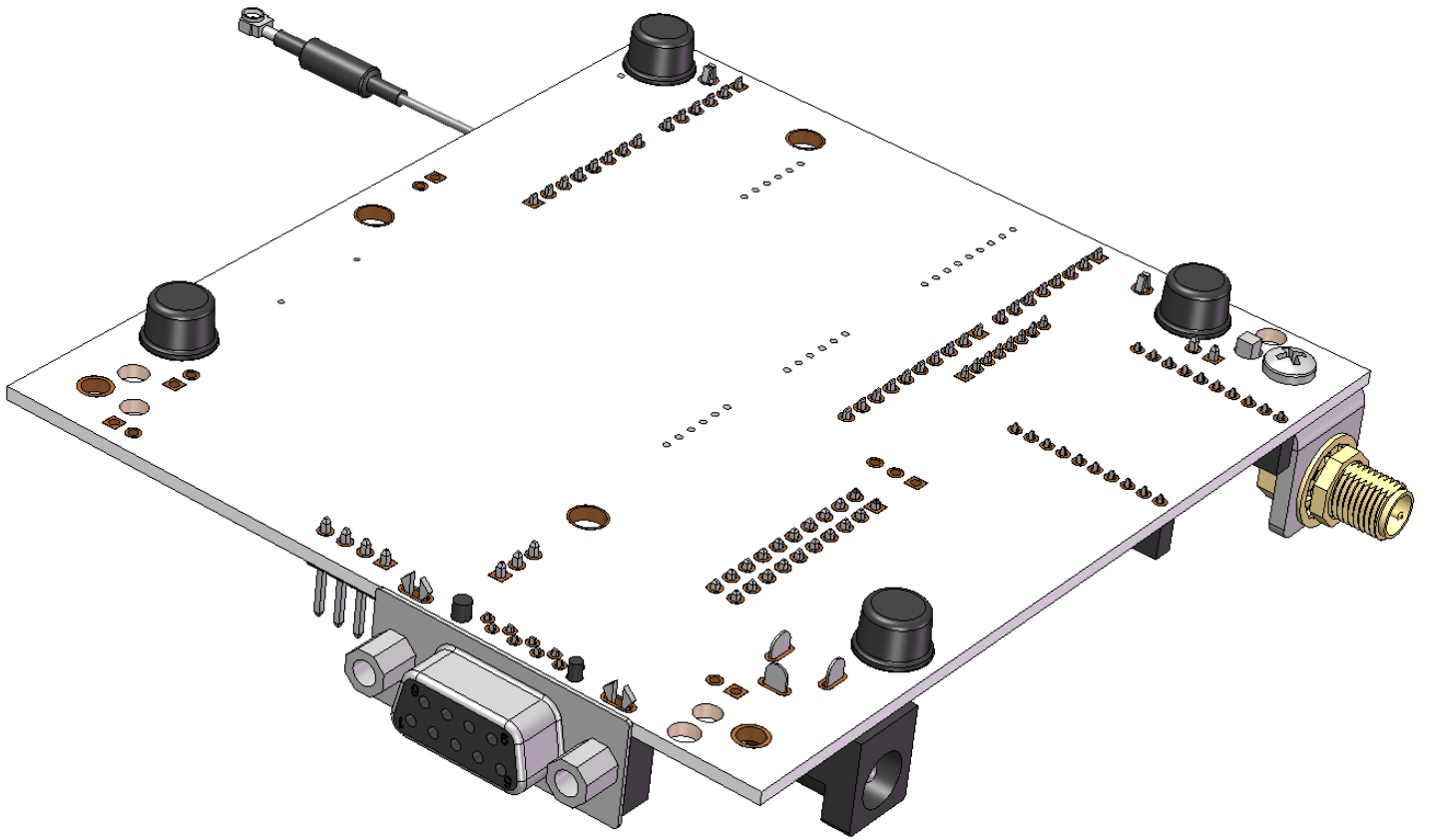

Developer Board Connectors

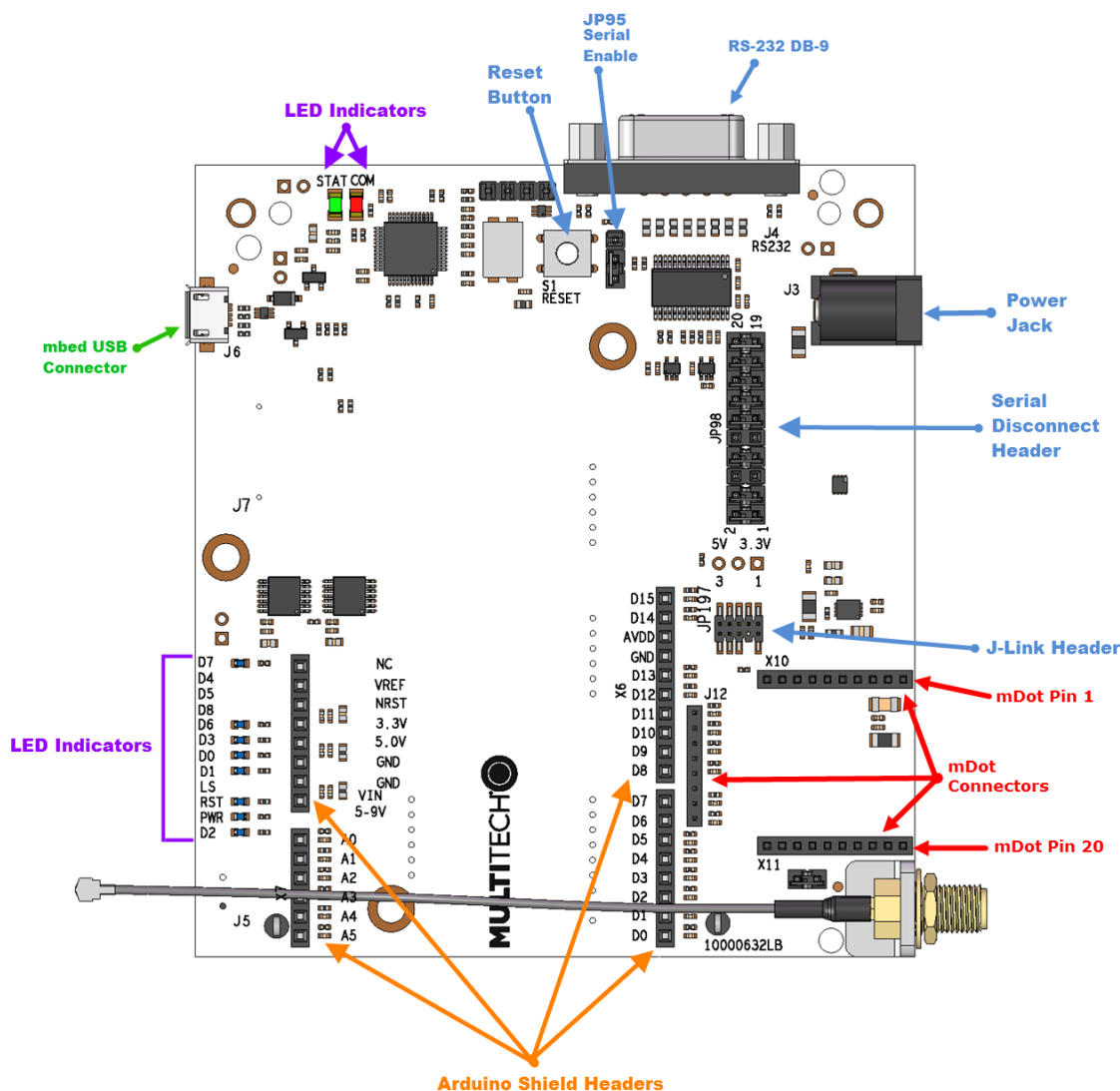

Note: The development board derives power from the USB connection. The Power Jack connects to the Arduino shield socket. If the Arduino shield needs 5 V, use a 5 V power supply. A 9 V supply will not be regulated down to 5 V.

Board Components

Label	Description
J4	RS232 DB-9 Serial Connector , used to access the mDot AT command interface.
J6	mbed USB Connector, attaches to the ST Micro controller. This provides access to two interfaces, one used to program the mDot and the other for debug messages.
JP98	Serial Disconnect Header. Pins D0-D8 are connected to the Arduino headers and the DB9 serial port. Remove these jumpers to disconnect from the RS232 transceiver chip.

Label	Description
JP197	J-Link Header, used for JTAG access to the mDot. This requires installing resistors R94-96 & 98 and removing R88-990 & 92. See Chapter 12 Developer Board Schematics .
S1	Reset Button. Use to reset the processor of the device attached to the board.
X6	Arduino Shield Connector.
X7	Arduino Shield Connector.
X8	Arduino Shield Connector.
X9	Arduino Shield Connector.
X10	MTDOT Connector.
X11	MTDOT Connector.
J12	MTDOT Programming Header.

CAUTION: Take care when connecting or disconnecting USB cables to avoid detaching the connector from the board.

LED Indicators

Label	LED	Location
STAT	LED1	Same side as RS-232 DB-9 connector
COM	LED2	Same side as RS-232 DB-9 connector
D7	LED3	Across the mDot connectors.
D6	LED7	Directly across from the mDot connectors.
D3	LED8	Directly across from the mDot connectors.
D0	LED9	Directly across from the mDot connectors.
D1	LED10	Directly across from the mDot connectors.
RST	LED12	Directly across from the mDot connectors.
PWR	LED13	Directly across from the mDot connectors.
D2	LED14	Directly across from the mDot connectors.

Chapter 11 – Chapter 11 Developer Board Installation

Installing an mDot on the Developer Board

To install an mDot on the Developer Board:

1. Align the mDot with the developer board as shown.

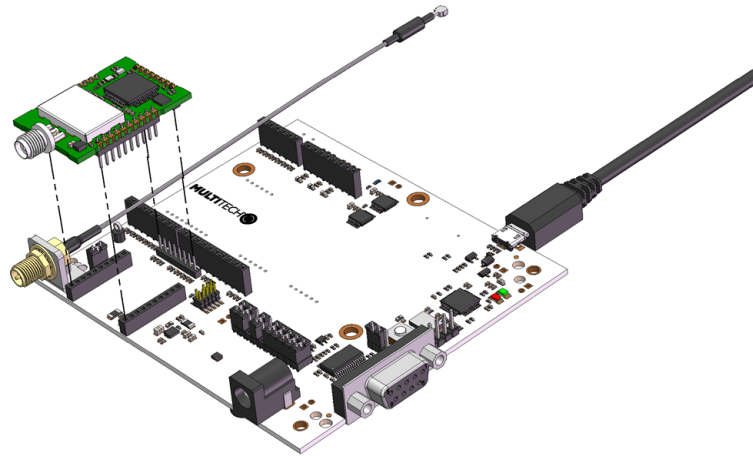

2. Gently press the mDot into the connectors.

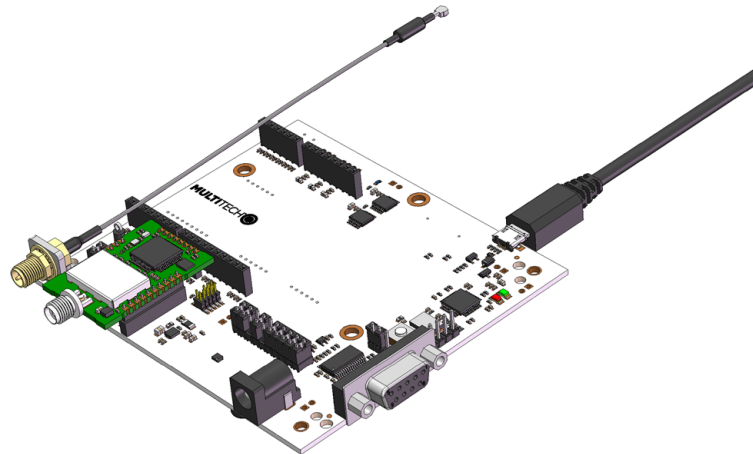

Arduino Shield

mDot Arduino Pins

Signals (module pin) micro pin		Arduino Shield					Signals (module pin) micro pin
					D15		PWM0/RSSI/I2CSCL (6) PA8
					D14		PWM1/I2CSDA (7) PC9
					AVDD		3.3V
					GND		Ground
3.3V			NC		D13	X6	AD2/DIO2/SCK (18) PA5
nReset, from pushbutton			VREF		D12		DO8/MISO (4) PA6
3.3V			nRST		D11		AD4/DIO4/MOSI (11) PA7
3.3V			3.3V		D10		AD3/DIO3/SNSS (17) PA4
5.0V	X9		5.0V		D9		no connect
Ground			GND		D8		no connect
Ground			GND				
5-9V input from J3			VIN		D7		nDTR/SleepRQ/DI8 (9) PA11
					D6		nRTS/AD6/DIO6 (16) PA1
AD0/DIO0 (20) PB1			A0		D5		no connect
AD1/DIO1 (19) PB0			A1		D4	X8	no connect
Associate/AD5/DIO5 (15) PC1	X7		A2		D3		nCTS/DIO7 (12) PA0
no connect			A3		D2		ON/nSleep (13) PC13
no connect			A4		D1		Dout (2) PA2
no connect			A5		D0		Din (3) PA3

Installing an Arduino Shield with an mDot

Note: When using an Arduino Shield with an mDot, install the mDot on the developer board before installing the Arduino shield.

To use an Arduino Shield with an mDot:

1. Disable the developer card's serial port by removing jumper from JP95.
 - Jumper pins 1-2: Disable U5 on USB VCC high.
 - Jumper pins 2-3: U5 always disabled.
 - Default jumper position is on pins 1-2.
2. Align the Arduino Shield on the developer board as shown.

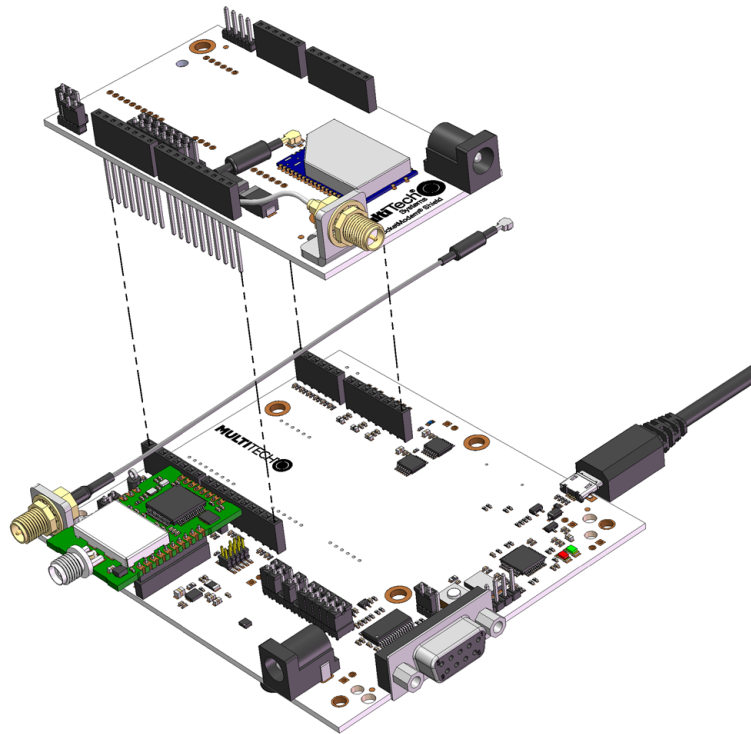

RSMA to U.FL Cables

The developer kit includes one 4.5" RSMA to U.FL cables which is preinstalled on the developer board.



Connecting an Antenna through the Developer Board Connectors

Depending on the mDot model, either connect the antenna directly to the mDot or through the RSMA-to-U.FL antenna cable on the developer board.

To connect an antenna to the device through the developer board:

1. Finger tighten the antenna to the SMA connector.

Chapter 12 – Chapter 12 Developer Board Schematics

About Schematics

The following schematics are for the fully populated MTUDK2 developer board and contain components not included on the MTUDK2-ST-MDOT model.

Block Diagram

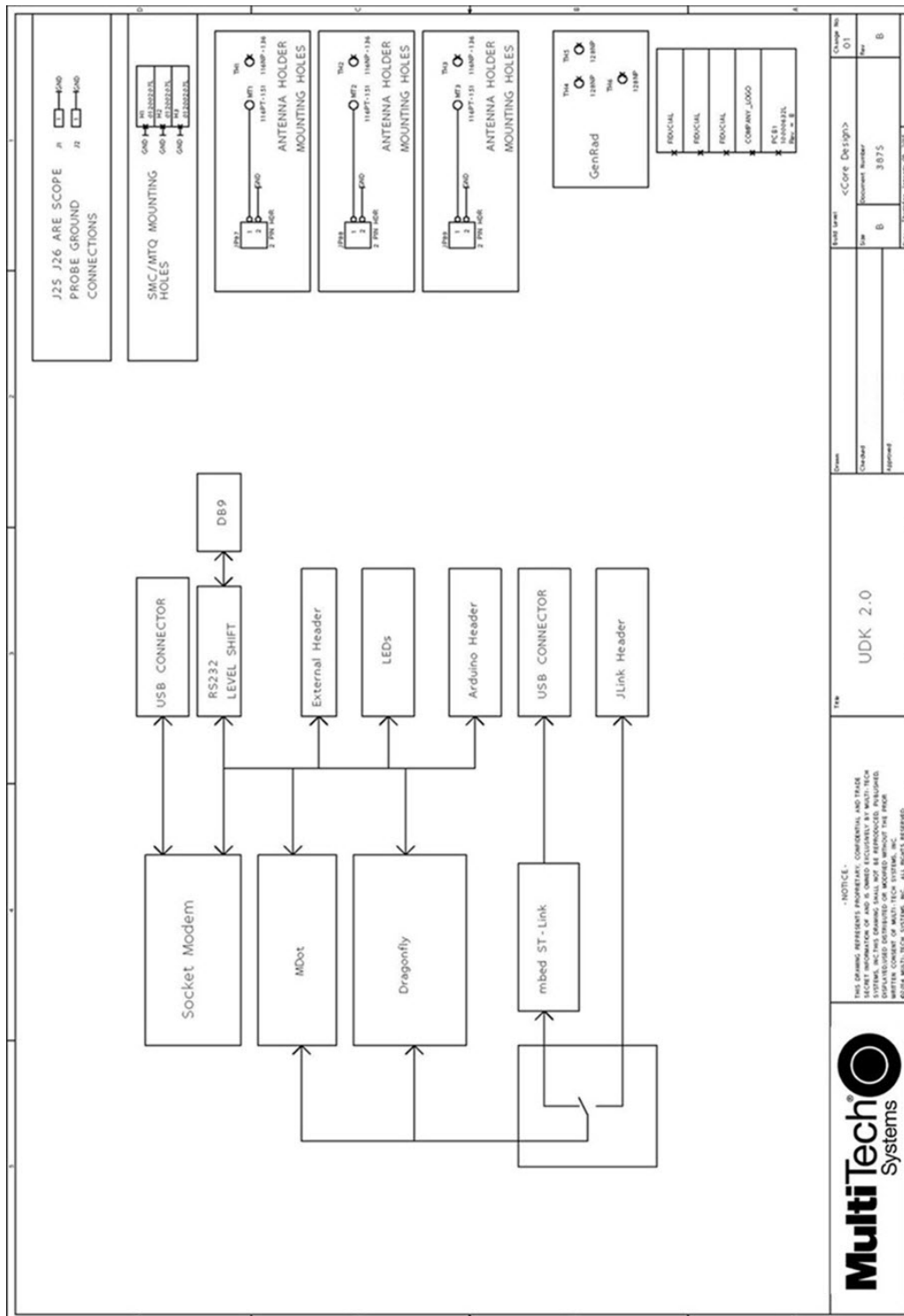

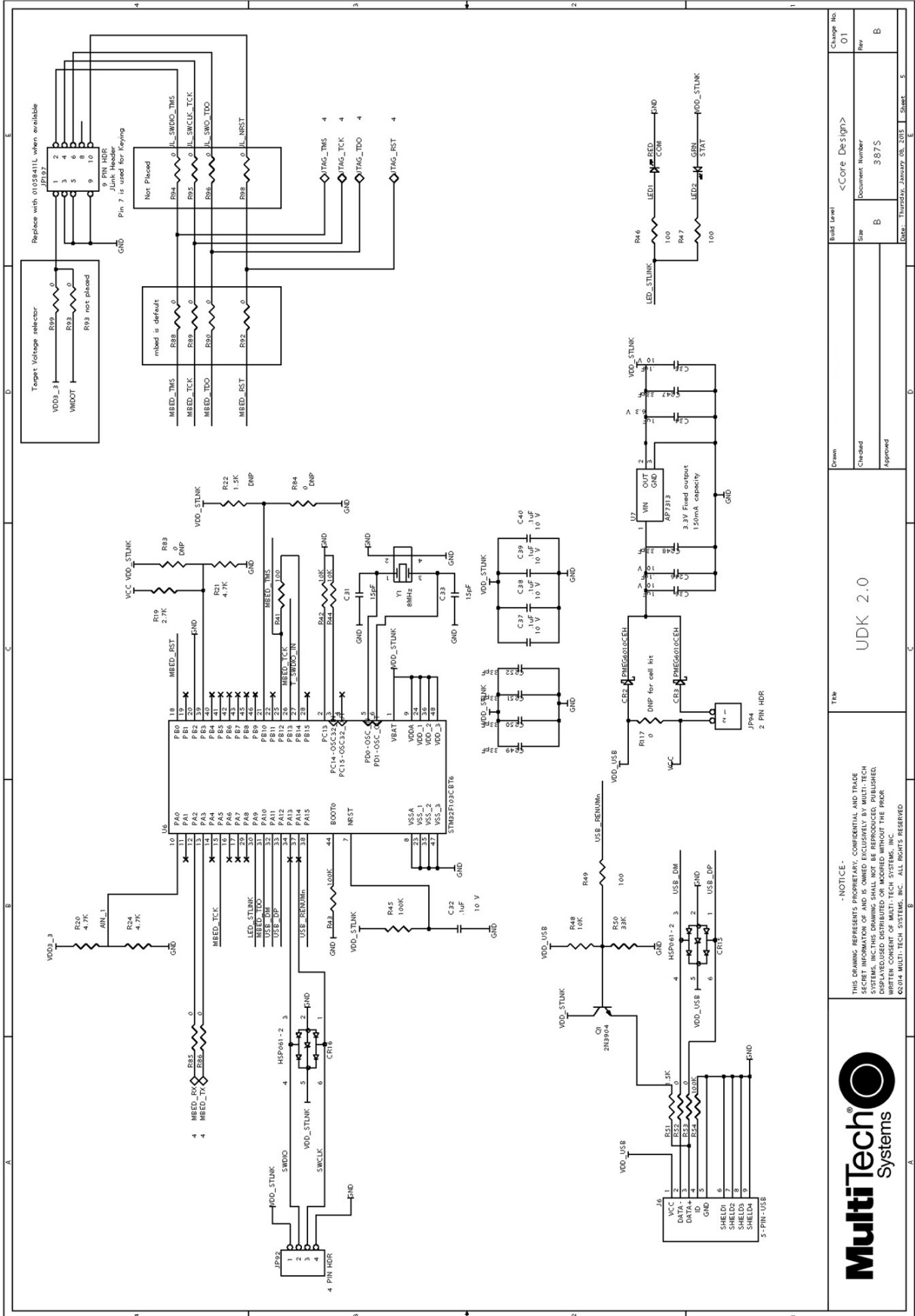

Change No.	01
Rev	B
Document Number	3875
Size	B
Date	Thursday, January 08, 2010
Sheet	5

Build Level: <Core Design>

Drawn: Checked: Approved:

UDK 2.0

- NOTICE -
THIS DRAWING REPRESENTS PROPRIETARY, CONFIDENTIAL AND TRADE SECRET INFORMATION OF MULTI-TECH SYSTEMS, INC. THIS DRAWING SHALL NOT BE REPRODUCED, PUBLISHED, COPIED, DISTRIBUTED OR MODIFIED WITHOUT THE PRIOR WRITTEN CONSENT OF MULTI-TECH SYSTEMS, INC.
©2004 MULTI-TECH SYSTEMS, INC. ALL RIGHTS RESERVED.

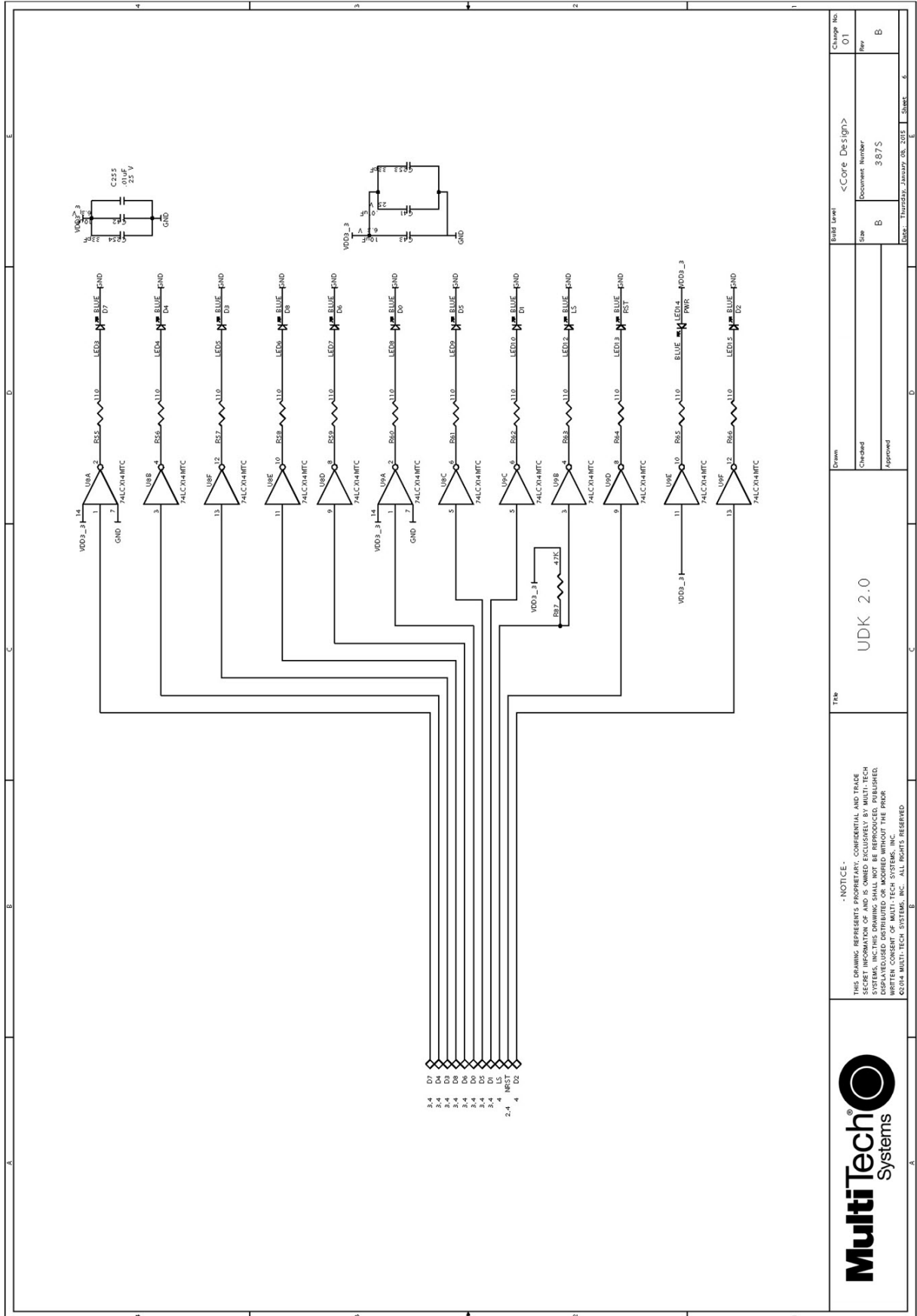

UDK 2.0		Title		- NOTICE - THIS DRAWING REPRESENTS PROPRIETARY, CONFIDENTIAL AND TRADE SECRET INFORMATION OF MULTI-TECH SYSTEMS, INC. ANY REPRODUCTION OR DISSEMINATION OF THIS DRAWING WITHOUT THE WRITTEN CONSENT OF MULTI-TECH SYSTEMS, INC. IS STRICTLY PROHIBITED. ©2014 MULTI-TECH SYSTEMS, INC. ALL RIGHTS RESERVED.	
Drawn	Checked	Approved	Drawn Level		
			<Core Design>		
Change No.	01	Rev	B		
Document Number	3575		Date: Thursday, January 08, 2015		
Size	B		Sheet 6		

Chapter 13 – Chapter 13 Micro Developer Kit

Micro Developer Kit

Designed specifically for mDot development, the Micro DK plugs directly into a USB port on your computer making it easy to use the developer kit for testing, programming, and evaluating your application.

Note: To work with the developer board, you need an X1P mDot model which includes a programming header.

Developer Kit Package Contents

Your Developer Kit (MTMDK-ST-MDOT) includes the following:

Developer Board	1 - MTMDK mDot Developer Board
Antenna	1 - 868-945 MHz LoRa Antenna
Cable	1 - Programming Cable
Customer Notices	This Quick Start

Update your developer board ST-LINK/V2 firmware through the mDot mbed page at

<https://developer.mbed.org/platforms/MTS-mDot-F411/#general-technical-references>

Firmware Updates

Before starting your project development, make sure you have the latest firmware for the Micro Developer Kit and mDot. Go to the mDot mbed page for MicroDK firmware. <https://developer.mbed.org/platforms/MTS-mDot-F411/>

Windows Drivers

For Windows 10, you do not need additional drivers.

For Windows 7, the MTMDK board has an Exar chip for the serial communication port and you need an Exar driver to send AT Command to the mDot. You do not need the ST-Link driver for the serial communication port (AT Commands). <https://www.exar.com/content/document.ashx?id=1596>.

To debug the processor with Windows 7, you do the ST-Link driver with the MTMDK board. <https://developer.mbed.org/teams/st/wiki/ST-Link-Driver>.

Note: You do not need a driver for the USB mass storage feature.

Micro Developer Board Components

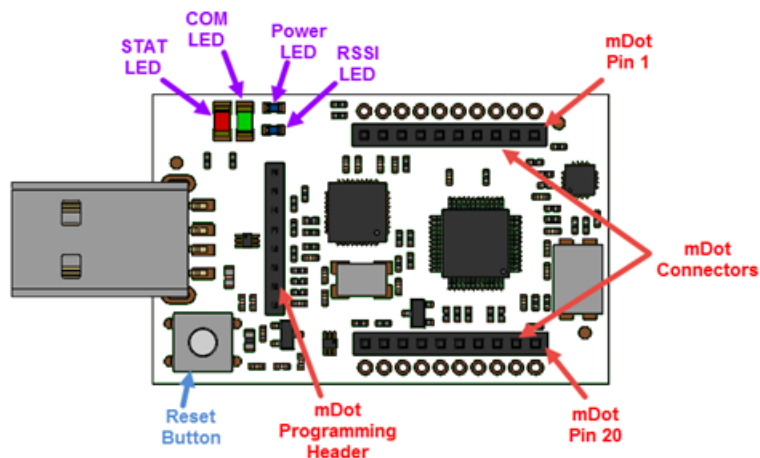

Note: The Reset Button resets the mDot processor.

LED	Description
STAT	LED1 Status, red light that blinks when device powers up.
COM	LED2 Communication, green light that shows when device is communicating.
PWR	LED3 Power, blue lights when the board has power.
RSSI	LED4 Received Signal Strength Indicator.

Installing an mDot on a Micro Developer Board

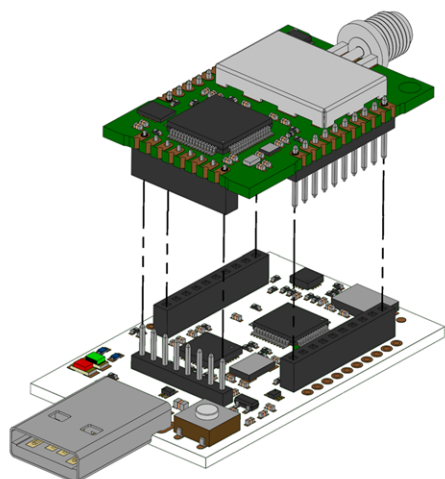

To install an mDot on the Micro Developer Board:

1. Align the mDot on the developer board as shown.
2. Gently press the mDot into the connectors.

Assembly Diagrams and Schematics

Assembly Diagrams

Top Assembly

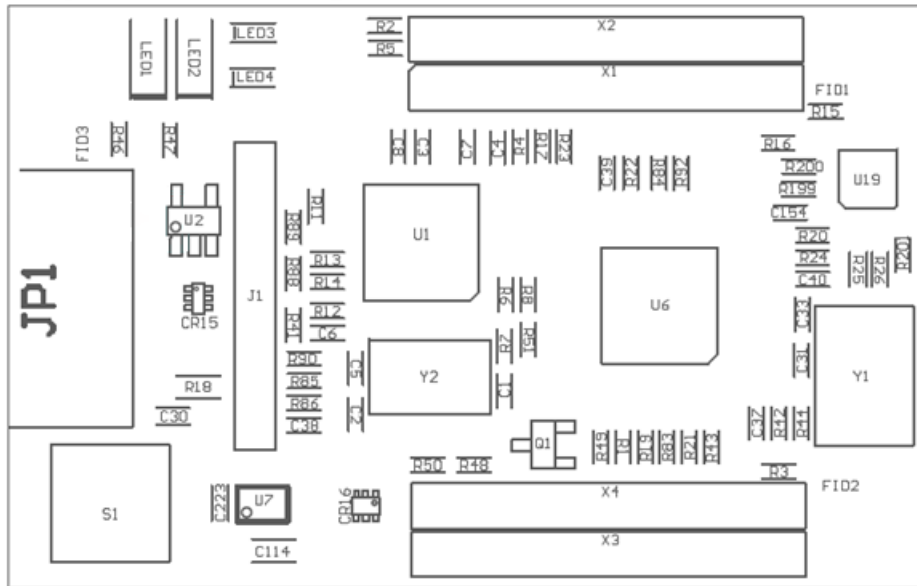

Bottom Assembly



Schematics

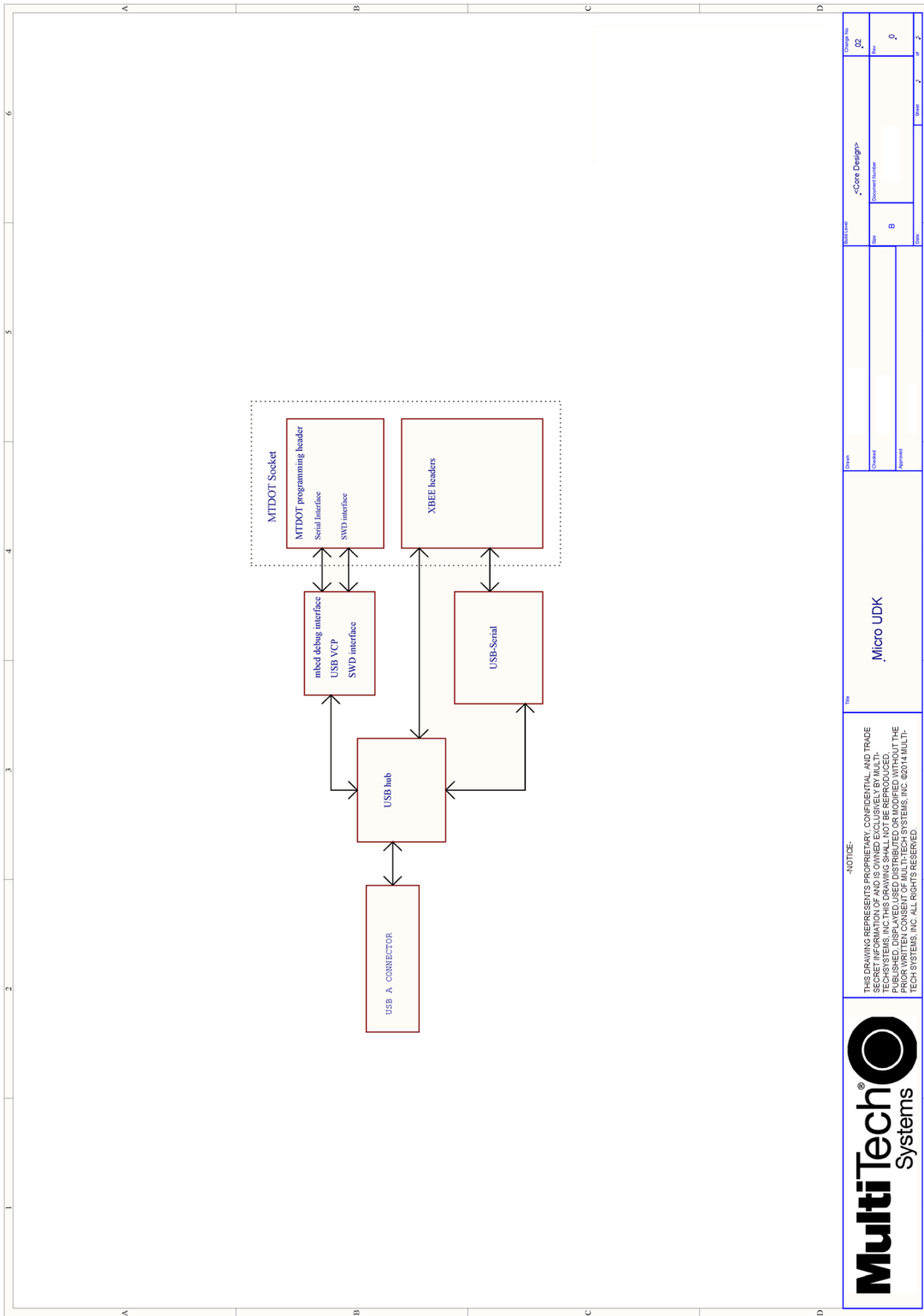

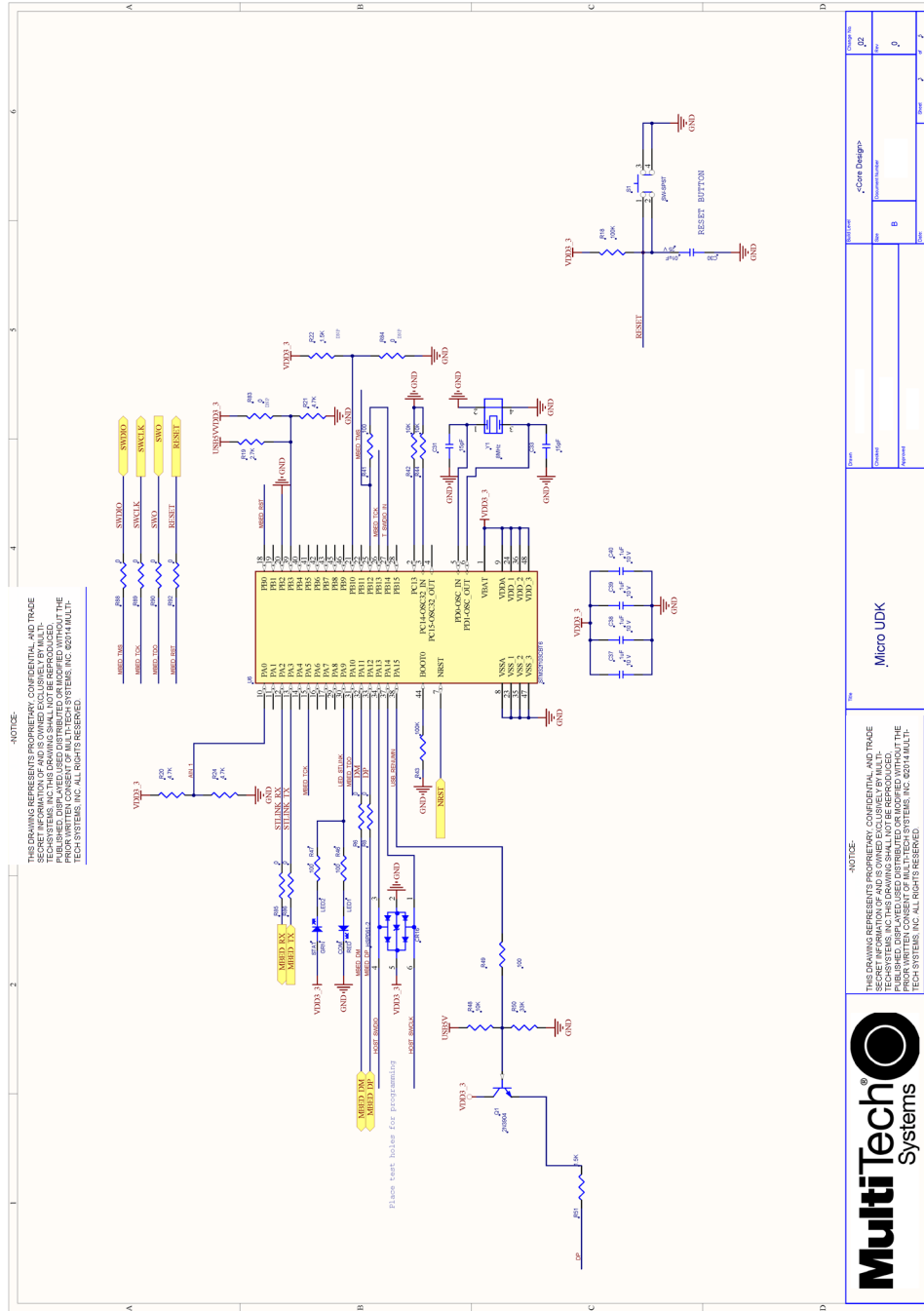

Note 1: Route USB traces as 90 ohm differential pairs.

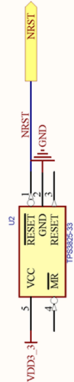
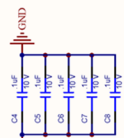
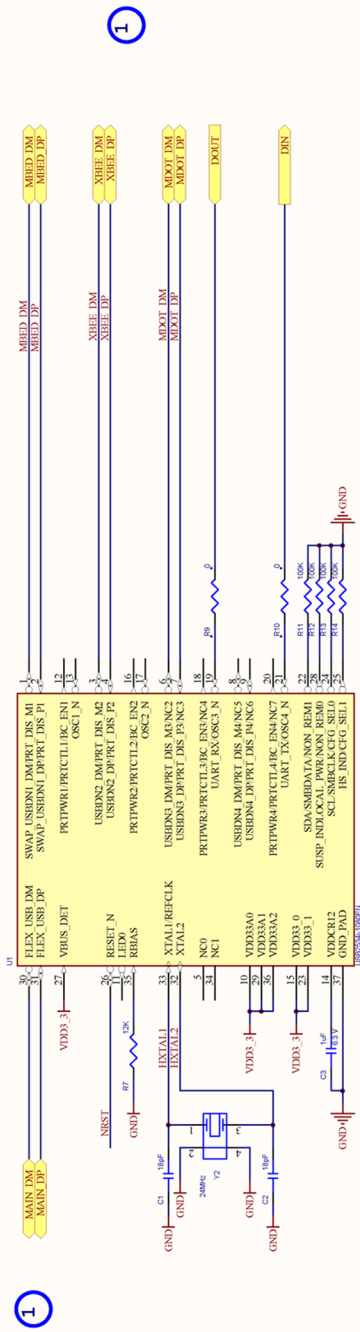

MultiTech
Systems

-NOTICE-
THIS DRAWING REPRESENTS PROPRIETARY, CONFIDENTIAL, AND TRADE SECRET INFORMATION OF AND IS OWNED EXCLUSIVELY BY MULTITECH SYSTEMS, INC. THIS DRAWING SHALL NOT BE REPRODUCED, PUBLISHED, DISPLAYED, USED, DISTRIBUTED OR MODIFIED WITHOUT THE EXPRESS WRITTEN CONSENT OF MULTITECH SYSTEMS, INC. ©2014 MULTITECH SYSTEMS, INC. ALL RIGHTS RESERVED.

Micro UDK

Drawn		Doc Name	<Core Design>	Change No	02
Checked		Date	B	Doc Number	407S
Approved		Rev	0	Rev	0

Chapter 14 – Chapter 14 Design Considerations

Noise Suppression Design

Adhere to engineering noise-suppression practices when designing a printed circuit board (PCB). Noise suppression is essential to the proper operation and performance of the modem and surrounding equipment.

Any OEM board design must consider both on-board and off-board generated noise that can affect digital signal processing. Both on-board and off-board generated noise that is coupled on-board can affect interface signal levels and quality. Noise in frequency ranges that affect modem performance is of particular concern.

On-board generated electromagnetic interference (EMI) noise that can be radiated or conducted off-board is equally important. This type of noise can affect the operation of surrounding equipment. Most local government agencies have certification requirements that must be met for use in specific environments.

Proper PC board layout (component placement, signal routing, trace thickness and geometry, and so on) component selection (composition, value, and tolerance), interface connections, and shielding are required for the board design to achieve desired modem performance and to attain EMI certification.

Other aspects of proper noise-suppression engineering practices are beyond the scope of this guide. Consult noise suppression techniques described in technical publications and journals, electronics and electrical engineering text books, and component supplier application notes.

PC Board Layout Guideline

In a 4-layer design, provide adequate ground plane covering the entire board. In 4-layer designs, power and ground are typically on the inner layers. Ensure that all power and ground traces are 0.05 inches wide.

The recommended hole size for the device pins is 0.036 in. +/-0.003 in. in diameter. Use spacers to hold the device vertically in place during the wave solder process.

Electromagnetic Interference

The following guidelines are offered specifically to help minimize EMI generation. Some of these guidelines are the same as, or similar to, the general guidelines. To minimize the contribution of device-based design to EMI, you must understand the major sources of EMI and how to reduce them to acceptable levels.

- Keep traces carrying high frequency signals as short as possible.
- Provide a good ground plane or grid. In some cases, a multilayer board may be required with full layers for ground and power distribution.
- Decouple power from ground with decoupling capacitors as close to the device's power pins as possible.
- Eliminate ground loops, which are unexpected current return paths to the power source and ground.
- Decouple the telephone line cables at the telephone line jacks. Typically, use a combination of series inductors, common mode chokes, and shunt capacitors. Methods to decouple telephone lines are similar to decoupling power lines; however, telephone line decoupling may be more difficult and deserves additional attention. A commonly used design aid is to place footprints for these components and populate as necessary during performance/EMI testing and certification.
- Decouple the power cord at the power cord interface with decoupling capacitors. Methods to decouple power lines are similar to decoupling telephone lines.

- Locate high frequency circuits in a separate area to minimize capacitive coupling to other circuits.
- Locate cables and connectors to avoid coupling from high frequency circuits.
- Lay out the highest frequency signal traces next to the ground grid.
- If using a multilayer board design, make no cuts in the ground or power planes and be sure the ground plane covers all traces.
- Minimize the number of through-hole connections on traces carrying high frequency signals.
- Avoid right angle turns on high frequency traces. Forty-five degree corners are good; however, radius turns are better.
- On 2-layer boards with no ground grid, provide a shadow ground trace on the opposite side of the board to traces carrying high frequency signals. This will be effective as a high frequency ground return if it is three times the width of the signal traces.
- Distribute high frequency signals continuously on a single trace rather than several traces radiating from one point.

Electrostatic Discharge Control

Handle all electronic devices with precautions to avoid damage due to the static charge accumulation.

See the ANSI/ESD Association Standard (ANSI/ESD S20.20-1999) – a document “for the Development of an Electrostatic Discharge Control for Protection of Electrical and Electronic Parts, Assemblies and Equipment.” This document covers ESD Control Program Administrative Requirements, ESD Training, ESD Control Program Plan Technical Requirements (grounding/bonding systems, personnel grooming, protected areas, packaging, marking, equipment, and handling), and Sensitivity Testing.

MultiTech strives to follow these recommendations. Input protection circuitry is incorporated in MultiTech devices to minimize the effect of static buildup. Take precautions to avoid exposure to electrostatic discharge during handling.

MultiTech uses and recommends that others use anti-static boxes that create a faraday cage (packaging designed to exclude electromagnetic fields). MultiTech recommends that you use our packaging when returning a product and when you ship your products to your customers.

USB Design

MultiTech recommends that you review Intel's High Speed USB Platform Design Guidelines for information about USB signal routing, impedance, and layer stacking. Also:

- Shield USB cables with twisted pairs (especially those containing D+/D-).
- Use a single 5V power supply for USB devices. See Power Draw for current (ampere) requirements.
- Route D+/D- together in parallel with the trace spacing needed to achieve 90 ohms differential impedance for the USB pair and to maintain a 20 mil space from the USB pair and all other signals.
- If power is provided externally, use a common ground between the carrier board and the device.

Chapter 15 – Appendix A Release Note Archi.ve

What's New in Firmware Version 2.0

The new release includes the following changes:

- LoRaWAN 1.01 Enhancements
- AU915 Support
- Class C
- US915 Test Mode

LoRaWan 1.0.1 Enhancement

Join Backoff updated to use the RTC clock to track time since the last join failure.

AU915 Support

AU915 support in this release as defined in LoRaWAN 1.01.

Class C

Allows the device to receive downlink packets from the network server without issuing an uplink first. Before the device can receive packets, it must first join the network via OTA or ABP. The device then listens for packets when idle, which leads to higher current consumption.

Configuration

Join via OTA or ABP as normal.

```
AT+DC=C
```

```
AT&W
```

```
AT+SD
```

Soon after being schedule to the network server, the device receives packets. If the network server requests an ACK, the device automatically sends an empty packet, only when the device is in serial data mode.

Network Server Configuration

After a device has joined via OTA or ABP, you can change from the default Class A setting. In the case of ABP join, the class can be set when you add the device.

```
lora-query -u <NODE-ADDR> class C
```

AT Commands Added or Changed in Version 2.0

The following AT Commands were added or modified in this release. Refer to the Dot Series AT Command Reference for details

Command	Function
AT+TXCH	Change, datarate range and current channel mask enabled settings are now shown in channel output.
AT+DC	Change. Class C allowed.

Command	Function
AT+SD	Change, if RX packet requires ACK or data pending bit is set, an empty packet is sent automatically.
AT+CHM	New, enables channel mask.
AT+MAC	New, injects MAC command.

Maintenance Release 1.0.8-1

Firmware release 1.0.8-1 addresses power consumption in sleep mode. For power draw changes, refer to notes and measurements in [Power Measurements](#).

What's New in Firmware Version 1.0

The release includes the following changes:

- Separate AT Command Reference Guide document, with expanded details.
- Enhanced support of LoRaWAN 1.0 and 1.0.1 specification.
- Adaptive Data Rate
- Peer to Peer
- EU868 Test Mode
- Enhanced sleep mode
- Preserve session

About Adaptive Data Rate

LoRaWAN provides MAC Commands, LinkADRReq and LinkADRAAns to support Adaptive Data Rate (ADR).

ADR allows the network server to change a device's data rate, Tx power, and repetition settings. If ADR is enabled, the network server samples the SNR from each packet and computes a possible data rate based on that sample. The possible data rate for a number of packets is held until the packet threshold is met. Once the threshold is met, a LinkADRAAns MAC command is sent to request that the device change data rate.

For the ADR to judge the SNR correctly, set Tx power to maximum. Greater power savings are achieved through Highest Power/Highest Data Rate than with Lowest Power/Lowest Data Rate. Each step in spreading factor/bandwidth (SD/BW) gives about 3 dB increase in link budget.

Once the highest data rate is assigned, the network server looks at adjusting Tx power. If the SNR ratio for the last several packets is 3 dB above the highest data rate threshold, power is lowered.

Related commands

AT+ADR – Enables adaptive data rate

AT+SDR - Shows the current data rate

Peer to Peer Communication

Peer to Peer mode allows mDots to communicate without a network server. Two mDots can be configured with identical network addresses and session keys and default to receive mode. In peer to peer mode, both mDots are

in listen mode when not transmitting and, if acknowledgments are enabled, every data packet is acknowledged immediately.

Note: In peer to peer mode, mDots only communicate with each other; mDots cannot make both peer to peer and network connections in the same session.

To use this feature, the following settings must match on each mDot.

Item	Command	Configuration
Network Address	AT+NA	<NET-ADDR>
Network Join Mode	AT+NJM	3
Network Session Key	AT+NSK	<NWK-SK>
Data Session Key	AT+DSK	<DATA-SK>
Transmit Frequency	AT+TXF	US 915MHz: Any; 915.5-919.7 is recommended
		EU 868MHz: FIXED at 869.85
Transmit Data Rate	AT+TXDR	US 915MHz: DR8-DR13
		EU 868MHz: DR0-DR6
TX/RX Inverted	AT+TXI, AT+RXI	0, 1 Use the AT+TXI setting for both
Require Acknowledgment	AT+ACK	0-8
Save Configuration	AT&W	
Serial Data Mode	AT+SD	

EU 868 Test Mode

This feature allows test mode for EU 868MHz devices as defined by the LoRa Alliance. Test mode is administered at the application level so the mDot must be joined to the network via ABPA or OTAA prior to testing.

Test mode allows you to test the mDot without special commands from the UI. Instead the network server initiates test mode with a special packet (0x01010101) on port 224. Once initiated, the server changes settings on the mDot through MAC commands and records the packets received from a number of attempts. Duty cycle limits are disabled during test mode.

The libmDot library now includes the test mode implementation, so an application built with libmDot will also have it. The libmDot library generates uplink packets and responds to commands from the network server test application.

Sleep Mode Enhancements

Changes to sleep mode include:

- Sleep mode now allows both Sleep Mode (stop) and Deep sleep (standby). Earlier firmware allowed only Deep sleep.
- Deep sleep has been changed to allow devices to wake on interval, interrupt, or both.
- Allow user to set a wake up pin for sleep mode.

Related Commands

- Sleep Mode (+SLEEP)
- Wake Mode (+WM)
- Wake Interval (+WI)
- Wake Pin (+WP)

Preserve Session

This feature allows you to preserve an AUTO_OTA LoRa Network session across power cycle or reset. The preserve session feature is applicable only when AT+NJM=2 (AUTO_OTA). However, AT+RS and AT+SS commands can be used with AT+NJM=1 or 0 (OTA or MANUAL) modes as well.

Related Commands

- Preserve Session (+PS)
- Restore Saved Session (+RS)
- Send using restored session (+SEND)
- Save Session (+SS)

AT Commands Added or Changed in Version 1.0

The following AT Commands were added or modified in this release. Refer to the MultiConnect Dot AT Command Reference for details

Command	Function
AT+TXCH	Change allows users to now add channels for EU 868MHz models.
AT+ULC	New, uplink counter
AT+DLC	New, downlink counter
AT+ANT	New, antenna gain
AT+JD	New, join delay
AT+RXD	New, receive delay
AT+TXDR	Change to data rate format
AT+SDR	New, displays the current data rate
AT+SDCE	New, serial data clear on error
AT&K0/3	New, hardware flow control
AT+DC	New, device class
AT+AP	New, application port
AT+SS	New, save network session
AT+RS	New, restore network session
AT+PS	New, preserve session

Index

schematics		
Micro Developer Board	61	
A		
adaptive data rate	70	
antenna	29	
connecting	50	
Arduino Shield	49	
assembly diagrams		
Micro Developer Board	61	
B		
battery draw down	21	
baud rate	27	
block diagram	52	
board components	46	
Micro Developer Board	60	
build options	10	
C		
cable	50	
certification		
FCC	35	
Industry Canada	36	
certifications	17	
Chinese hazardous substances		
Chinese version	40	
English version	39	
Class B	34	
Industry Canada	35	
class C	69	
Conduit	8	
connectors	46	
D		
data bits	27	
dc characteristics	22	
deep sleep mode	71	
device		
maintenance	32	
documentation	8	
E		
electromagnetic interference	67	
electrostatic discharge	68	
EMI	67	
ESD	68	
EU 868 test mode	71	
EUI	10	
F		
FCC		
grant notes	30	
FCC certification	35	
FCC Notice		
Class B	34	
flow control	27	
G		
ground plane	67	
H		
handling precautions due to ESD	68	
hazardous substances	38	
host labeling	30	
I		
identifier	10	
IMEI location	41	
Industry Canada	36	
Class B	35	
install mDot	48	
Micro Developer Board	60	
interférence des radiofréquences	31	
K		
KDB 447498 Section 8	30	
L		
labeling		
host	30	
labels	41	

LED indicators.....47
 LoRa
 range27

M

maintenance32
 mbed9
 mechanical drawings12 13 14 15 16
 Micro Developer Board.....59
 MTAC-LORA.....8
 MTCDT.....8
 MultiConnect8

N

networking10
 noise suppression.....67

P

packing list43 58
 parity27
 PC board layout.....67
 peer to peer70
 pin information23
 pinout notes27
 power21
 preserve session.....72

R

radio frequency interference31
 range27
 receive sensitivity.....17
 related products.....8
 reset28
 RoHS.....38

RSMA to U.FL cable.....50

S

safety
 RF interference31
 safety standards.....67
 schematics.....53
 serial settings27
 sleep mode.....71
 SMA to U.FL.....50
 specifications.....17
 static.....31
 STmicro processor.....8
 stop bits.....27
 sécurité
 interférences RF.....31

T

test mode71
 trace antenna29
 transmission17

U

U.FL50
 U.FL antenna29
 USB
 design consideration.....68
 user responsibility.....33

W

wake71