

### 224/225 Series Lead-Free 2AG, Fast-Acting

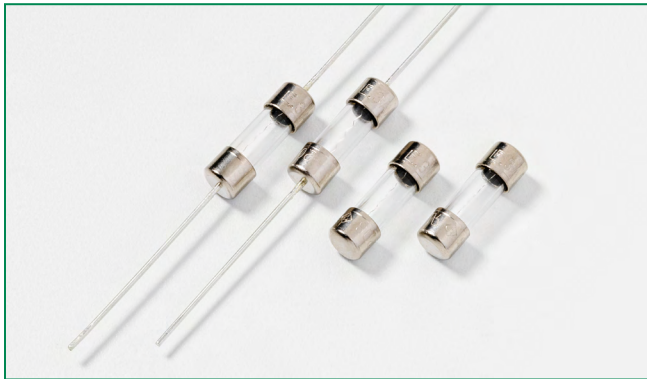

#### Description

The 2AG Fast-Acting Fuses are available in cartridge form or with axial leads. 2AG Fuses provide the same performance characteristics as their 3AG counterpart, while occupying one-third the space. Sleeved fuses are available.

#### Features

- In accordance with Underwriter's Laboratories Standard UL 248-14
- Available in cartridge and axial lead form and with various forming dimensions
- RoHS compliant and Lead-free





#### Applications

Used as supplementary protection in appliance or utilization equipment to provide individual protection for components or internal circuits.

#### Electrical Characteristics for Series

% of Ampere Rating	Opening Time
100%	4 hours, Minimum
135%	1 hour, Maximum
200%	1 sec., Maximum

#### Agency Approvals

Agency	Agency File Number	Ampere Range
	E10480	0.375A - 3.5A
	E10480	4A - 10A
	29862	0.375A - 10A
	NBK200405-E10480A/B/C/D NBK110512-E10480A/B NBK210405-E10480E/F	1A - 3.5A 4A - 5A 6A - 10A
	N/A	0.375A - 10A

#### Additional Information



Datasheet  
224 Series



Resources  
224 Series



Samples  
224 Series



Datasheet  
225 Series



Resources  
225 Series







Samples  
225 Series



Accessories  
224 & 225 Series

For recommended fuse accessories for this product series, see ['Recommended Accessories'](#) section.

#### Electrical Characteristic Specifications by Item

Amp Code	Ampere Rating (A)	Voltage Rating (V)	Interrupting Rating	Nominal Cold Resistance (Ohms)	Nominal Melting I <sup>2</sup> t (A <sup>2</sup> sec)	Agency Approvals				
										
.375	0.375	250	35A@250Vac 10KA@125Vac 10KA@125Vdc	0.3950	0.171	x		x		x
.500	0.5	250		0.2650	0.365	x		x		x
.750	0.75	250		0.1520	1.050	x		x		x
001.	1	250		0.1027	2.220	x		x	x	x
01.5	1.5	250	0.0712	0.800	x		x	x	x	
002.	2	250	100A@250Vac	0.0497	2.180	x		x	x	x
02.5	2.5	250	10KA@125Vac	0.0372	3.820	x		x	x	x
003.	3	250	10KA@125Vdc	0.0317	4.620	x		x	x	x
03.5	3.5	250		0.0265	6.700	x		x	x	x
004.	4	125	100A@250Vac	0.0240	9.400		x	x	x	x
005.	5	125	500A@125Vac	0.0186	17.0		x	x	x	x
005.	5	250		0.0186	17.0		x	x		x
006.	6	125		0.0154	22.1		x	x	x	x
007.	7	125	500A@125Vac	0.0130	40.0		x	x	x	x
008.	8	125		0.0107	56.0		x	x	x	x
010.	10	125		0.0075	116.0		x	x	x	x

\* 10A with 500A @ 125 Vdc internal breaking capacity testing.

### Temperature Re-rating Curve

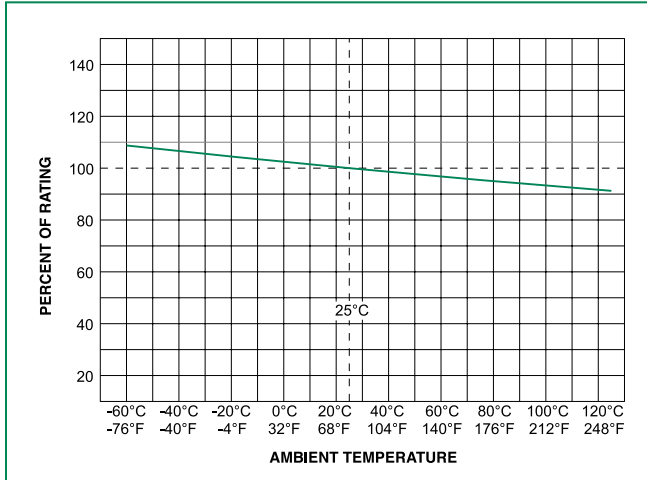

Note:  
 Rerating depicted in this curve is in addition to the standard derating of 25% for continuous operation.

### Average Time Current Curves

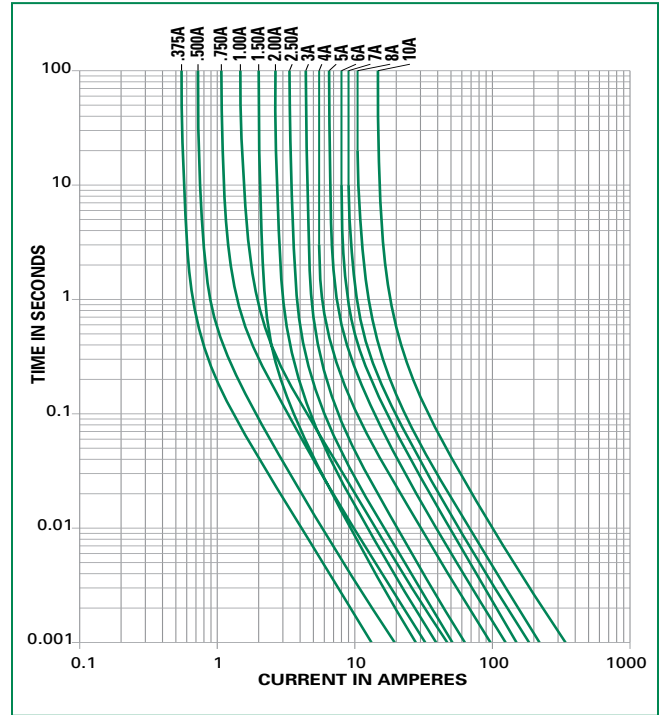

### Soldering Parameters - Wave Soldering

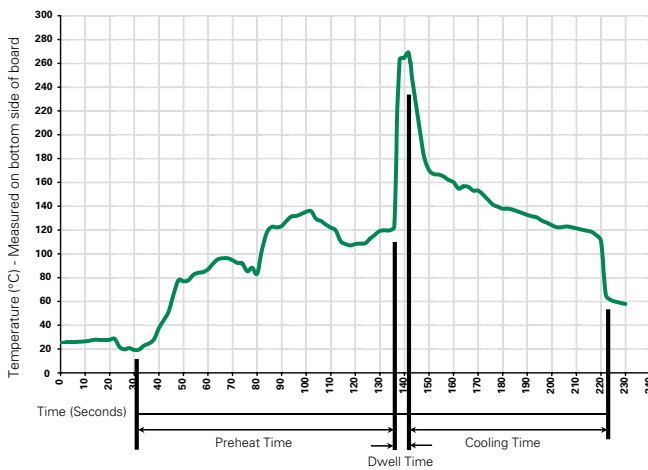

### Recommended Process Parameters:

Wave Parameter	Lead-Free Recommendation
<b>Preheat:</b> (Depends on Flux Activation Temperature) (Typical Industry Recommendation)	
Temperature Minimum:	100°C
Temperature Maximum:	150°C
Preheat Time:	60-180 seconds
<b>Solder Pot Temperature:</b>	260°C Maximum
<b>Solder Dwell Time:</b>	2-5 seconds

### Recommended Hand-Solder Parameters:

Solder Iron Temperature: 350°C +/- 5°C  
 Heating Time: 5 seconds max.

**Note: These devices are not recommended for IR or Convection Reflow process.**

### Product Characteristics

<b>Materials</b>	Body : Glass Cap : Nickel-plated brass Leads: Tin-plated Copper
<b>Terminal Strength</b>	MIL-STD-202, Method 211, Test Condition A
<b>Solderability</b>	MIL-STD-202 Method 208
<b>Product Marking</b>	Cap1 : Brand logo, current and voltage ratings Cap2 : Series and agency approval marks

<b>Operating Temperature:</b>	-55°C to 125°C.
<b>Thermal Shock:</b>	MIL-STD-202, Method 107, Test Condition B (5 Cycles -65°C to +125°C).
<b>Vibration</b>	MIL-STD-202, Method 201
<b>Humidity</b>	MIL-STD-202, Method 103, Test Condition A: High RH (95%) and elevated temp (40°C) for 240 hours
<b>Salt Spray</b>	MIL-STD-202, Method 101, Test Condition B

### Dimensions

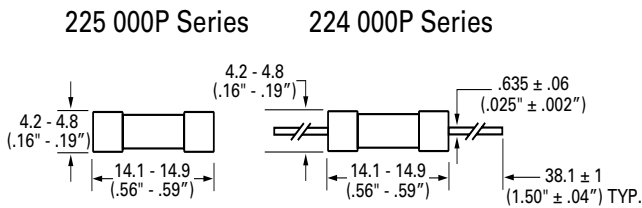

### Part Numbering System

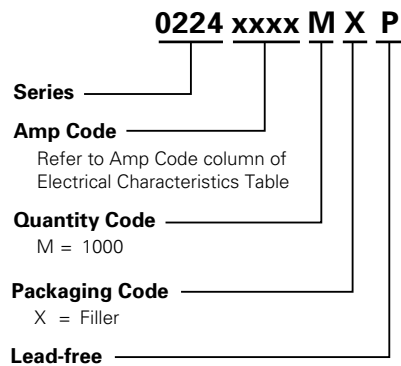

**Note:** The ratings from 4A to 10A with MXUP in the suffix

### Packaging

Packaging Option	Packaging Specification	Quantity	Quantity & Packaging Code	Taping Width
<b>224 Series</b>				
Bulk	N/A	1000	MX	N/A
Bulk	N/A	100	HX	N/A
Reel and Tape	EIA 296-E	1500	DRT1	T1=53mm (2.087")
<b>225 Series</b>				
Bulk	N/A	1000	MX	N/A
Bulk	N/A	100	HX	N/A

### Recommended Accessories

Accessory Type	Series	Description	Max Application Voltage	Max Application Amperage
Holder	<a href="#">245</a>	Panel Mount Shock-Safe Fuseholder	300	10
	<a href="#">150</a>	In-Line Fuseholder	350	10
	<a href="#">286</a>	Panel Mount Flip-Top Shock-Safe Fuseholder	250	10
Block	<a href="#">254</a>	OMNI-BLOK® Fuse Block	400	10
Clip	<a href="#">111</a>	PC Board Mount Fuse Clip	250	10

- Notes:
- Do not use in applications above rating.
  - Please refer to fuseholder data sheet for specific re-rating information.
  - Please contact factory for applications greater than the max voltage and amperage shown.