

MAXIM

MAX1586A Evaluation Kit/ Evaluation System

Evaluate: MAX1586A

General Description

The MAX1586A evaluation kit (EV kit) is a fully assembled and tested surface-mount PCB that evaluates the MAX1586A power-management IC (PMIC). The IC is optimized for microprocessor-based applications. The MAX1586A integrates three high-performance synchronous step-down DC-DC power supplies, three low-dropout (LDO) regulators, a battery backup supply, and various power-management functions.

The MAX1586A evaluation system (EV system) consists of a MAX1586A evaluation kit (EV kit) and a companion Maxim CMAXQUSB board.

The Maxim SMBus™ interface board (CMAXQUSB) allows a PC to use its USB port to emulate an SMBus/I²C-compatible 2-wire interface. Windows® 98SE/2000/XP-compatible software provides a professional interface to exercise the features of the MAX1586A. The program is menu driven and offers a graphical user interface (GUI) with control buttons and a status display.

The MAX1586AEVCMAXQU includes both the EV kit and the CMAXQUSB interface board. Order the MAX1586A EV kit if you already have an SMBus interface.

SMBus is a trademark of Intel Corp.

Windows is a registered trademark of Microsoft Corp.

Features

- ◆ **2.6V to 5.5V Single-Supply Operation**
- ◆ **Seven-Output Power Supply**
 - 3.3V at 1.3A (VCC_I/O)
 - 2.5V at 900mA (VCC_MEM)
 - 0.7 to 1.475V at 500mA (VCC_CORE) Software Adjustable
 - 1.3V at 35mA (VCC_PLL)
 - 1.1V at 40mA (VCC_SRAM)
 - 0 to 3V at 35mA (VCC_USIM) Software Adjustable
- ◆ **Backup Battery Supply (30mA)**
- ◆ **1MHz Switching Frequency**
- ◆ **On-Board Manual Reset Switch**
- ◆ **Optional On-Board Power-Sequencing Circuitry**
- ◆ **Power-OK Output**
- ◆ **SMBus/I²C-Compatible 2-Wire Serial Interface**
- ◆ **Easy-to-Use Menu-Driven Software**
- ◆ **Software-Controlled Core and USIM Voltage Adjustment**
- ◆ **Assembled and Tested**
- ◆ **Include Windows 98SE/2000/XP-Compatible Software**
- ◆ **Also Evaluate the MAX1586B**
- ◆ **EV System Includes USB Connectivity**

Ordering Information

PART	TEMP RANGE	IC PACKAGE	SMBus INTERFACE TYPE
MAX1586AEVKIT	0°C to +70°C	48 Thin QFN	Not included
MAX1586AEVCMAXQU	0°C to +70°C	48 Thin QFN	CMAXQUSB+

Note: The MAX1586A EV kit software is provided with the MAX1586AEVKIT; however, the CMAXQUSB+ board is required to interface the EV kit to the computer when using the included software.

Component Suppliers

SUPPLIER	PHONE	FAX	WEBSITE
Central Semiconductor	631-435-1110	631-435-1824	www.centralsemi.com
Sumida USA	847-545-6700	847-545-6720	www.sumida.com
TDK Corp.	847-803-6100	847-390-4405	www.component.tdk.com
TOKO America, Inc.	847-297-0070	847-699-1194	www.tokoam.com

Note: Indicate that you are using the MAX1586A when contacting these component suppliers.



For pricing, delivery, and ordering information, please contact Maxim/Dallas Direct! at 1-888-629-4642, or visit Maxim's website at www.maxim-ic.com.

MAX1586A Evaluation Kit/ Evaluation System

Component Lists

MAX1586A EV System

PART	QTY	DESCRIPTION
MAX1586AEVKIT	1	MAX1586A EV kit
CMAXQUSB+	1	Serial-interface board

+Denotes lead free and RoHS compliance.

MAX1586A EV Kit

DESIGNATION	QTY	DESCRIPTION
C1–C6	0	Not installed, capacitors (0603)
C7	0	Not installed, capacitor (0805)
C8, C9, C10	0	Not installed, capacitors (0402)
C11, C15, C16, C17, C29, C30, C33	7	10 μ F \pm 20%, 6.3V X5R ceramic capacitors (0805) TDK C2012X5R0J106M
C12, C13, C14, C31, C32	5	4.7 μ F \pm 20%, 6.3V X5R ceramic capacitors (0805) TDK C2012X5R0J475M
C18	1	1500pF \pm 10%, 50V X7R ceramic capacitor (0402) TDK C1005X7R1H152K
C19	1	0.1 μ F \pm 20%, 10V X5R ceramic capacitor (0402) TDK C1005X5R1A104M
C20	1	0.01 μ F \pm 20%, 25V X7R ceramic capacitor (0402) TDK C1005X7R1E103M
C21–C25	5	1.0 μ F \pm 20%, 10V X5R ceramic capacitors (0603) TDK C1608X5R1A105M

MAX1586A EV Kit (continued)

DESIGNATION	QTY	DESCRIPTION
C26, C28	2	330pF \pm 5%, 50V C0G ceramic capacitors (0603) TDK C1608C0G1H331J
C27	1	270pF \pm 5%, 50V C0G ceramic capacitor (0603) TDK C1608C0G1H271J
D1	1	Switching diode (SOT323) Central Semiconductor CMSD4448
J1	1	2 x 10 right-angle female receptacle
JU1–JU9	9	Jumpers, 3-pin headers
L1	1	3.3 μ H, 2.66A inductor TOKO A915AY-3R3M
L2	1	6.8 μ H, 1.51A inductor TOKO A915AY-6R8M
L3	1	10 μ H, 0.85A inductor Sumida CDRH2D18/HP-100 TOKO A960AW-100M
R1–R6, R14, R15	0	Not installed, resistors (0603)
R7–R13, R24, R25	0	Not installed, resistors (0402)
R16–R20	5	1M Ω \pm 5% resistors (0402)
R21, R22, R23	3	240k Ω \pm 1% resistors (0402)
SW1	1	Momentary pushbutton switch
U1	1	MAX1586AETM (48-pin Thin QFN)
—	9	Shunts
—	1	PCB: MAX1586A Evaluation Kit
—	1	Software disk (CD-ROM) "MAX1586A Evaluation Kit"

Quick Start

Recommended Equipment

- 4.5V, 2A DC power supply
- 3.6V backup battery (optional)
- One voltmeter
- MAX1586A EV system
 - MAX1586A EV kit
 - Maxim CMAXQUSB interface board (USB cable included)
- A user-supplied Windows 98SE/2000/XP PC with a spare USB port

Note: In the following sections, software-related items are identified by bolding. Text in **bold** refers to items directly from the EV kit software. Text in **bold and underlined** refers to items from the Windows 98SE/2000/XP operating system.

Procedure

The MAX1586A EV kit is fully assembled and tested. Follow the steps below to verify board operation. Do not turn on the power supply until all connections are completed:

- 1) Visit the Maxim website (www.maxim-ic.com/evkit-software) to download the latest version of the EV kit software, 1586ARxx.ZIP.

MAX1586A Evaluation Kit/ Evaluation System

- 2) Install the MAX1586A evaluation software on your computer by running the INSTALL.EXE program inside the temporary folder. The program files are copied and icons are created in the Windows **Start** menu.
- 3) On the CMAXQUSB board, ensure that shunt JU1 is in the 3.3V position.
- 4) Carefully connect the boards by aligning the MAX1586A EV kit's 20-pin connector with the 20-pin header of the CMAXQUSB interface board. Gently press them together. The two boards should be flush against each other.
- 5) Ensure that a shunt is placed across pins 1-2 of jumpers JU1–JU7.
- 6) Ensure that a shunt is placed across pins 2-3 of jumpers JU8 and JU9. Do not turn on the power until all connections are made.
- 7) Connect the 4.5V power supply to the pads labeled VIN and GND on the MAX1586A EV kit board.
- 8) Connect the optional backup battery to the pads labeled BKBT and GND.
- 9) Connect a voltmeter to the pads labeled VCC_CORE and GND.
- 10) Connect the USB cable from the PC to the CMAXQUSB board. A **Building Driver Database** window pops up in addition to a **New Hardware Found** message if this is the first time this board is connected to the PC. If you do not see a window that is similar to the one described above after 30 seconds, remove the USB cable from the CMAXQUSB and reconnect it again. Administrator privileges are required to install the USB device driver on Windows 98SE/2000/XP. Refer to the TROUBLESHOOTING_USB.PDF document included with the software if you have any problems during this step.
- 11) Follow the directions of the **Add New Hardware Wizard** to install the USB device driver. Choose the **Search for the best driver for your device** option. Specify the location of the device driver to be **C:\Program Files\MAX1586A** (default installation directory) by using the **Browse** button.
- 12) Turn on the DC power supply.
- 13) Start the MAX1586A EV kit software by opening its icon in the **Start** menu. The GUI main window appears as shown in Figure 1.

- 14) Move the **Core Voltage** track bar located inside the **Voltage Control** group box to 1V.
- 15) Verify that the VCC_CORE voltage on the voltmeter reads approximately 1V.

__Detailed Description of Software

User-Interface Panel

The user interface (Figure 1) is easy to operate; use the mouse or press the Tab key to navigate with the arrow keys. Each button corresponds to bits in the command and configuration bytes. By clicking on them, the correct SMBus write operation is generated to update the internal registers of the MAX1586A. The **Interface** box

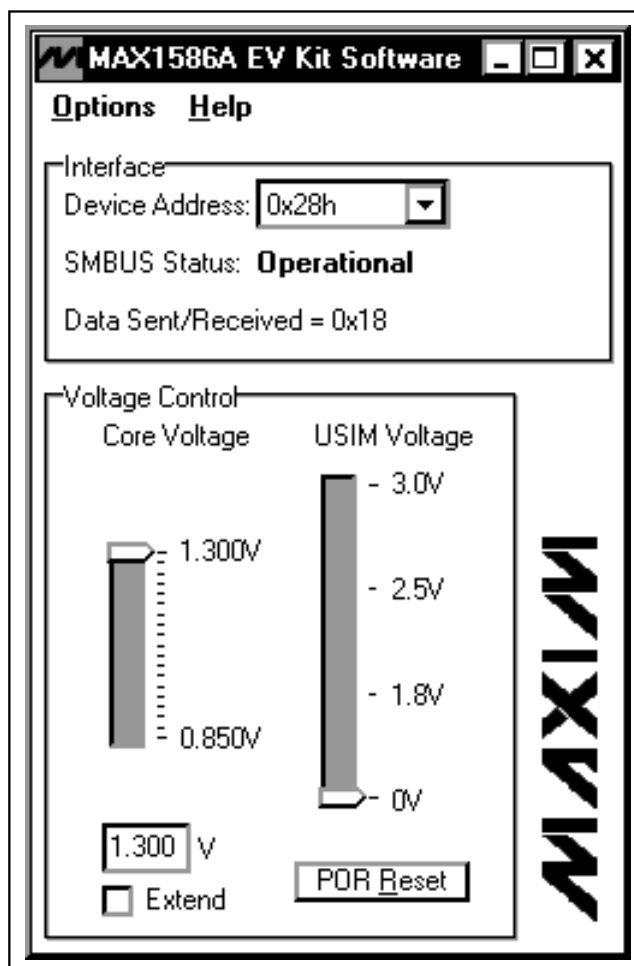

Figure 1. MAX1586A EV Kit Software Main Window

MAX1586A Evaluation Kit/ Evaluation System

indicates the current **Device Address**, the **Data Sent/Received** (the MAX1586A EV kit software only sends) for the last read/write operation. This data is used to confirm proper device operation.

Note: Words in boldface are user-selectable features in the software.

Core Voltage Control

The core voltage (VCC_CORE) can be adjusted in 25mV increments by adjusting the **Core Voltage** slider. Alternatively, a number can be entered in the box below the **Core Voltage** slider. If a number not divisible by 0.025 is entered, the software automatically rounds the number to the nearest 25mV increment and sends the appropriate data to the MAX1586A.

Check the **Extend** checkbox to increase the core voltage range to 0.7V to 1.475V.

USIM Voltage Control

The USIM voltage (VCC_USIM) can be adjusted to one of four preset voltages. Adjust the **USIM Voltage** slider to select the desired voltage.

Simple SMBus Commands

There are two methods for communicating with the MAX1586A: through the normal user-interface panel or through the SMBus commands available by selecting the **2-Wire Interface Diagnostic** item from the **Options** pulldown menu. A display pops up that allows the SMBus protocols, such as Read Byte, Write Byte, and Send Byte, to be executed.

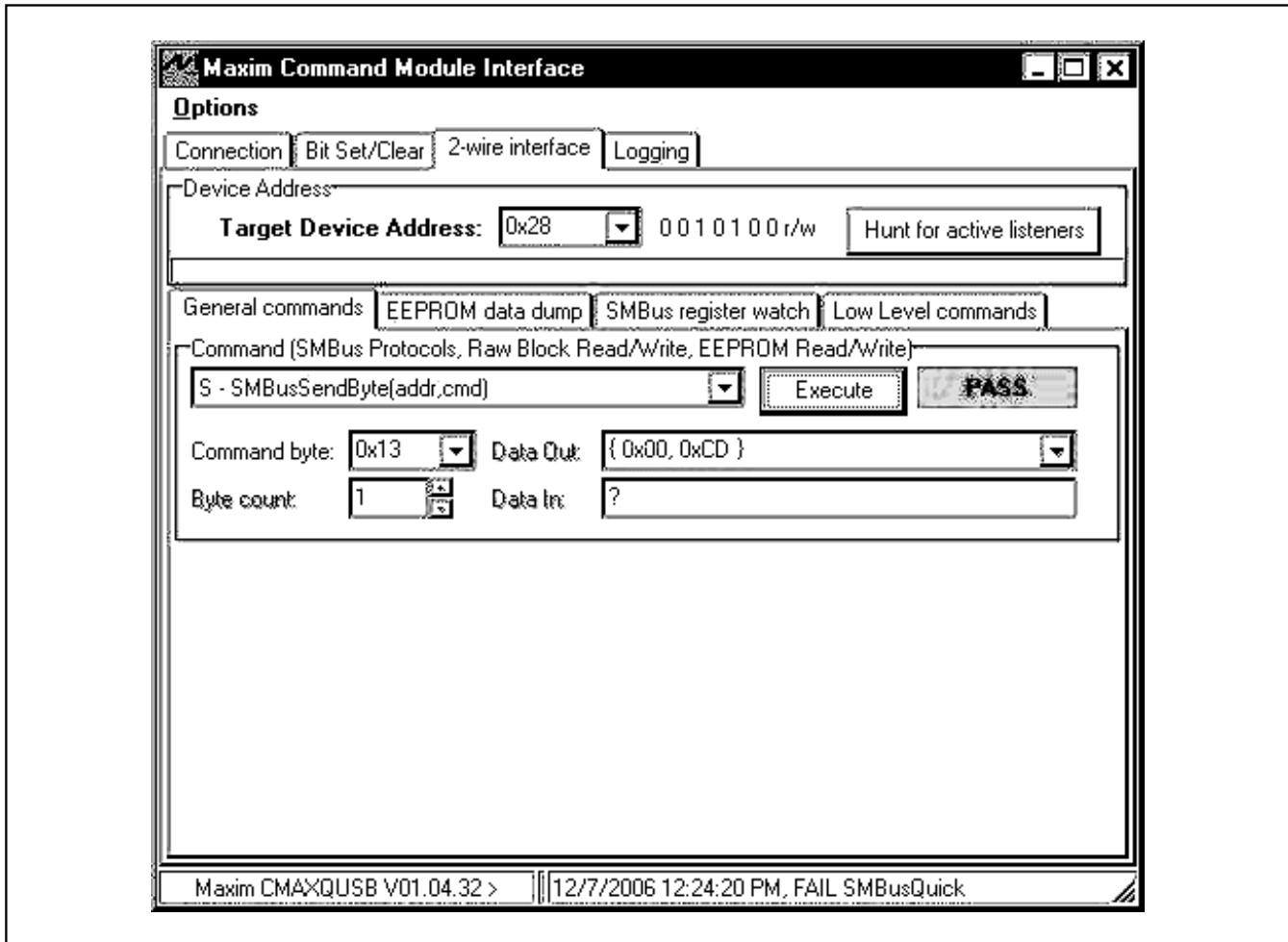

Figure 2. A Simple SMBusSendByte Operation Using the Included 2-Wire Interface Diagnostics. In this example, the software is writing data (0x13) to Device Address 0x28. The above data sequence sets the core voltage of the MAX1586A to 1.175V.

MAX1586A Evaluation Kit/ Evaluation System

Evaluate: MAX1586A

The SMBus dialog boxes accept numeric data in binary, decimal, or hexadecimal form. Hexadecimal numbers should be prefixed by \$ or 0x. Binary numbers must be exactly eight digits. See Figure 2 for an example of this tool.

Note: In places where the slave address asks for an 8-bit value, it must be the 7-bit slave address of the MAX1586A as determined by SRAD with the last bit set to 1 for a read operation or zero for a write. Refer to the MAX1586A data sheet for a complete list of registers and functions.

Detailed Description of Hardware

The MAX1586A EV kit is a fully assembled and tested surface-mount PCB that evaluates the MAX1586A PMIC. The MAX1586A integrates three high-performance, 1MHz, synchronous step-down DC-DC power supplies, three low-dropout regulators, and a battery backup supply.

The power outputs consist of a 3.3V at 1.3A I/O (VCC_I/O) step-down output, a 2.5V at 900mA memory (VCC_MEM) step-down output, a software-adjustable 0.7V to 1.475V at 500mA core (VCC_CORE) step-down output, a 1.3V at 35mA phase-locked loop (VCC_PLL) LDO, a 1.1V at 40mA SRAM (VCC_SRAM) LDO, and a software-adjustable 0 to 3.0V at 35mA (VCC_USIM) LDO. An additional 30mA backup battery (VCC_BATT) output is also available.

Power-management functions include a power-OK (POK) output, a manual reset input, multiple output-enable inputs, a sleep function, and a reset output. Activate the manual reset input by pressing the switch labeled SW1.

Power sequencing is also available through component placeholders R1–R6 and C1–C6. See the *Optional Power-Sequencing Circuitry* section in the document for more details.

Address Selection

Jumper JU9 sets the MAX1586A slave address. The default address is 0010 1000 (SRAD = GND). See Table 1 for a complete list of addresses.

Table 1. Shunt Settings for SMBus Address (JU9)

SHUNT POSITION	MAX1586A ADDRESS PIN	MAX1586A ADDRESS	
		BINARY	HEXADECIMAL
1-2	VIN	0010 1010	0x2A
2-3*	GND	0010 1000	0x28

*Default configuration: JU9 (2-3)

Sleep Mode

Jumper JU7 controls the sleep function of the MAX1586A EV kit. Removing the shunt from JU7 allows the sleep function to be controlled by an external signal source connected to the SLP pad. See Table 2 for sleep shunt positions.

Table 2. Sleep Selection (JU7)

SHUNT POSITION	DESCRIPTION
1-2*	I/O and MEM DC-DC converters enabled.
2-3	I/O and MEM DC-DC converters disabled. I/O and MEM sleep LDOs enabled.
Not installed	SLP function controlled by an external signal source.

*Default configuration: JU7 (1-2)

MAX1586A Evaluation Kit/ Evaluation System

Table 3. Output Enable (JU1–JU6)

JUMPER	SHUNT POSITION	DESCRIPTION
JU1 (ON1)	1-2*	VCC_I/O output enabled.
	2-3	VCC_I/O output disabled.
	Not installed	ON1 controlled by an external signal source.
JU2 (ON2)	1-2*	VCC_MEM output enabled.
	2-3	VCC_MEM output disabled.
	Not installed	ON2 controlled by an external signal source.
JU3 (ON3)	1-2*	VCC_CORE output enabled.
	2-3	VCC_CORE output disabled.
	Not installed	ON3 controlled by an external signal source.
JU4 (ON4)	1-2*	VCC_PLL output enabled.
	2-3	VCC_PLL output disabled.
	Not installed	ON4 controlled by an external signal source.
JU5 (ON5)	1-2*	VCC_SRAM output enabled.
	2-3	VCC_SRAM output disabled.
	Not installed	ON5 controlled by an external signal source.
JU6 (ON6)	1-2*	VCC_USIM output enabled.
	2-3	VCC_USIM output disabled.
	Not installed	ON6 controlled by an external signal source.

*Default configuration: JU1 (1-2), JU2 (1-2), JU3 (1-2), JU4 (1-2), JU5 (1-2), JU6 (1-2)

Output Enables

Jumpers JU1–JU6 control the on/off state of the MAX1586A EV kit VCC_I/O, VCC_MEM, VCC_CORE, VCC_PLL, VCC_SRAM, and VCC_USIM outputs. Removing the shunt allows the output enable function to be controlled by an external signal source. See Table 3 for output enable shunt positions.

Pulse-Skipping Mode

Jumper JU8 controls the pulse-skipping mode of the VCC_CORE output. See Table 4 for pulse-skipping mode shunt positions.

Table 4. Pulse-Skipping Mode Selection (JU8)

SHUNT POSITION	DESCRIPTION
1-2	VCC_CORE pulse-skipping mode disabled (forced PWM).
2-3*	VCC_CORE pulse-skipping mode enabled.

*Default configuration: JU8 (2-3)

Adjusting the I/O Voltage

The VCC_I/O (I/O) output voltage can be adjusted from its default value of 3.3V. Cut the trace at R12 and install a 0Ω resistor at R24 to set the I/O voltage to 3.0V. To set the I/O voltage to an alternative value, cut the trace at R12 and install resistors at R10 and R12. Use the equation below to calculate resistor values:

$$R_{10} = R_{12} \times \left(\frac{V_{CC_I/O}}{V_{FB1}} - 1 \right)$$

where:

$$R_{12} = 100k\Omega$$

$$V_{CC_I/O} = \text{desired I/O voltage}$$

$$V_{FB1} = 1.25V$$

Adjusting the MEM Voltage

The VCC_MEM (MEM) output voltage can be adjusted from its default value of 2.5V. Cut the trace at R13 and install a 0Ω resistor at R18 to set the MEM voltage to 1.8V. To set the MEM voltage to an alternative value, cut the trace at R13 and install resistors at R11 and R13. Use the equation below to calculate resistor values:

$$R_{11} = R_{13} \times \left(\frac{V_{CC_MEM}}{V_{FB2}} - 1 \right)$$

where:

$$R_{13} = 100k\Omega$$

$$V_{CC_MEM} = \text{desired MEM voltage}$$

$$V_{FB2} = 1.25V$$

MAX1586A Evaluation Kit/ Evaluation System

Low-Battery Detection

The MAX1586A is capable of monitoring the main battery input voltage and activating outputs when the voltage falls below a given threshold. The default EV kit configuration triggers the low-battery output when the input voltage falls below 3.6V. The dead-battery output is triggered when the input voltage falls below 3.2V. Monitor the outputs at the $\overline{\text{LBO}}$ and $\overline{\text{DBO}}$ pads.

To alter the EV kit defaults, cut the trace at R7 and R8 and install resistors at locations R7, R8, and R9. Use the following equations to calculate resistor values:

$$R_8 = \left(\frac{\text{DBI}}{\text{LBI}} \times \frac{V_{\text{inL}}}{V_{\text{inD}}} - 1 \right) \times R_9$$

$$R_7 = R_9 \times \left(\frac{V_{\text{inL}}}{\text{LBI}} - 1 \right) - R_8$$

where:

LBI = 1.0V

DBI = 1.232V

V_{inL} = desired low-battery detection voltage

V_{inD} = desired dead-battery detection voltage

R_9 = 100k Ω

Note: The following conditions must be met:

$V_{\text{inL}} \geq \text{LBI}$ (1.0V)

$V_{\text{inD}} \geq \text{DBI}$ (1.232V)

Optional Power-Sequencing Circuitry

The MAX1586A EV kit provides extra pads to support power sequencing. The directions below describe the implementation of this feature.

- 1) Cut the trace at R1–R6.
- 2) To create an RC time delay:
Install resistors and capacitors at locations R1–R6 and C1–C6.
- 3) Ensure that shunts are installed across pins 1 and 2 of jumpers JU1–JU6.

Calculate component values using the equation below:

$$R_n = \frac{-t}{C_n \times \ln\left(1 - \frac{V_{\text{TH}}}{V_{\text{in}}}\right)}$$

where:

C_n = 0.1 μF

V_{TH} = 1.1V

V_{in} = battery input voltage

t = desired startup time

Using an Alternative SMBus Interface

The MAX1586A EV kit provides pads and pullup resistor placeholders that allow an alternative SMBus/I²C-compatible interface to be used. Connect the interface through the SCL, SDA, and GND pads. Install pullup resistors at positions R14 and R15 if required.

Evaluating the MAX1586B

To evaluate the MAX1586B, replace IC U1 with a MAX1586BETM.

MAX1586A Evaluation Kit/ Evaluation System

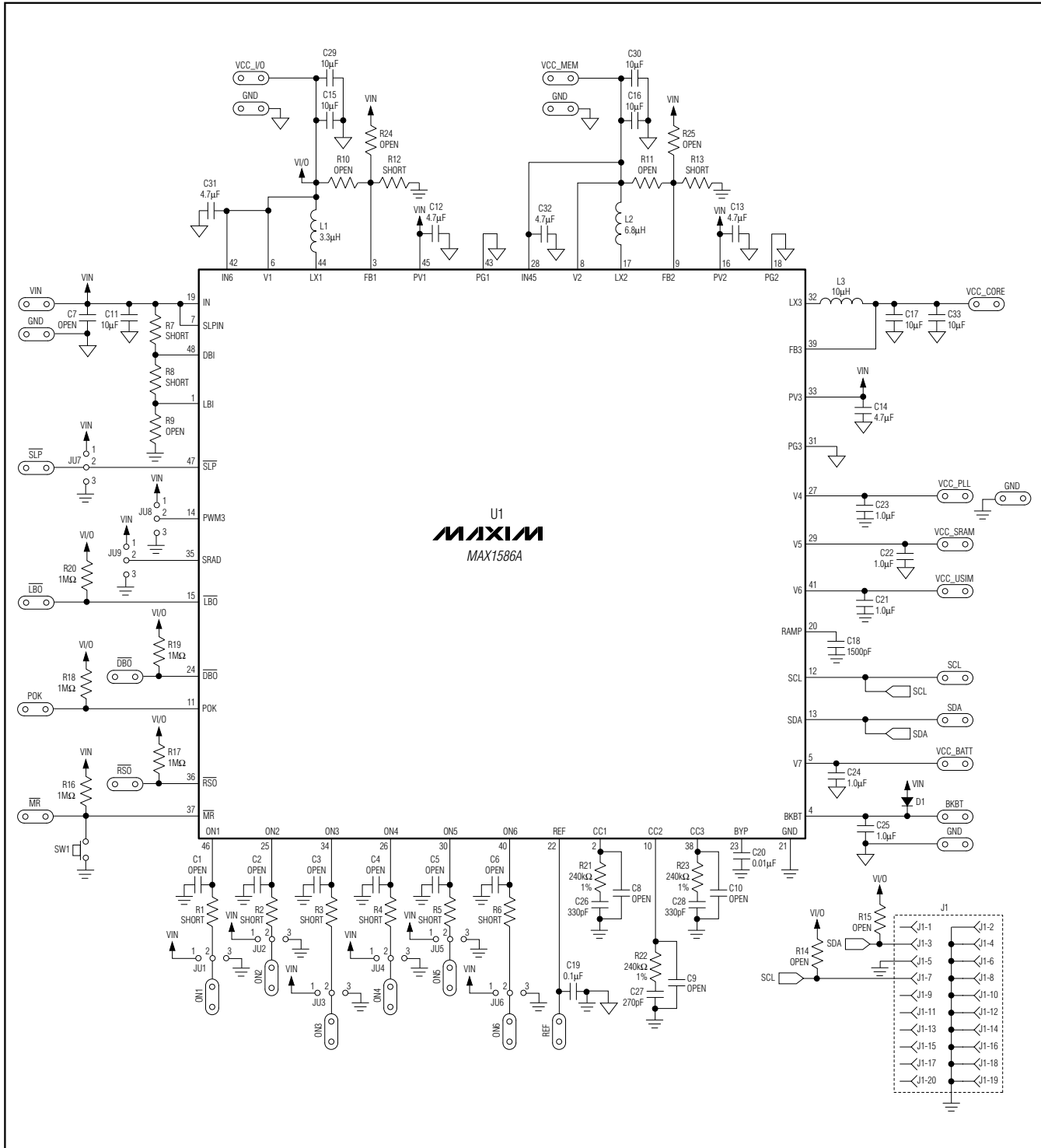

Figure 3. MAX1586A EV Kit Schematic

MAX1586A Evaluation Kit/ Evaluation System

Evaluate: MAX1586A

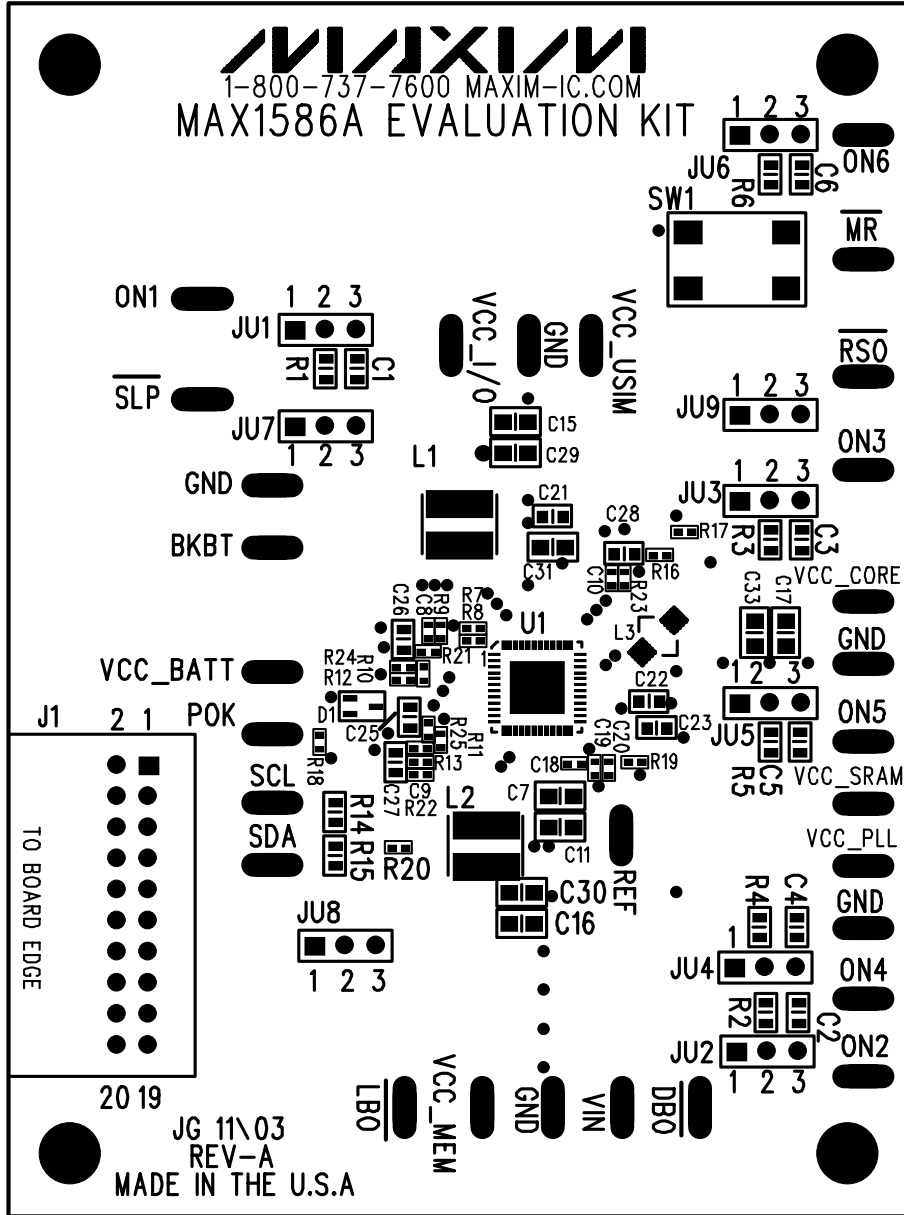

Figure 4. MAX1586A EV Kit Component Placement Guide—Component Side

MAX1586A Evaluation Kit/ Evaluation System

Evaluate: MAX1586A

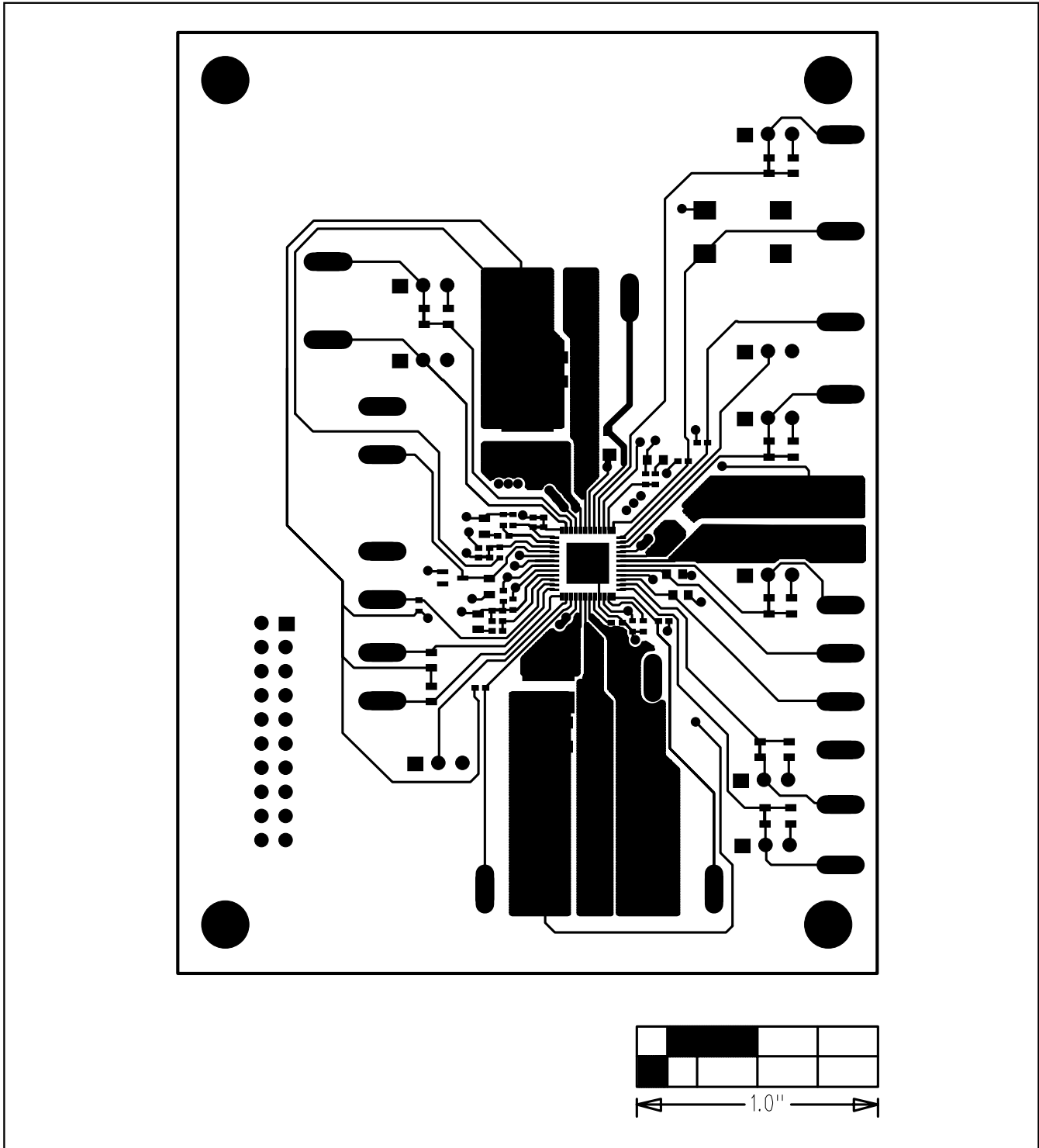

Figure 5. MAX1586A EV Kit PCB Layout—Component Side

MAX1586A Evaluation Kit/ Evaluation System

Evaluate: MAX1586A

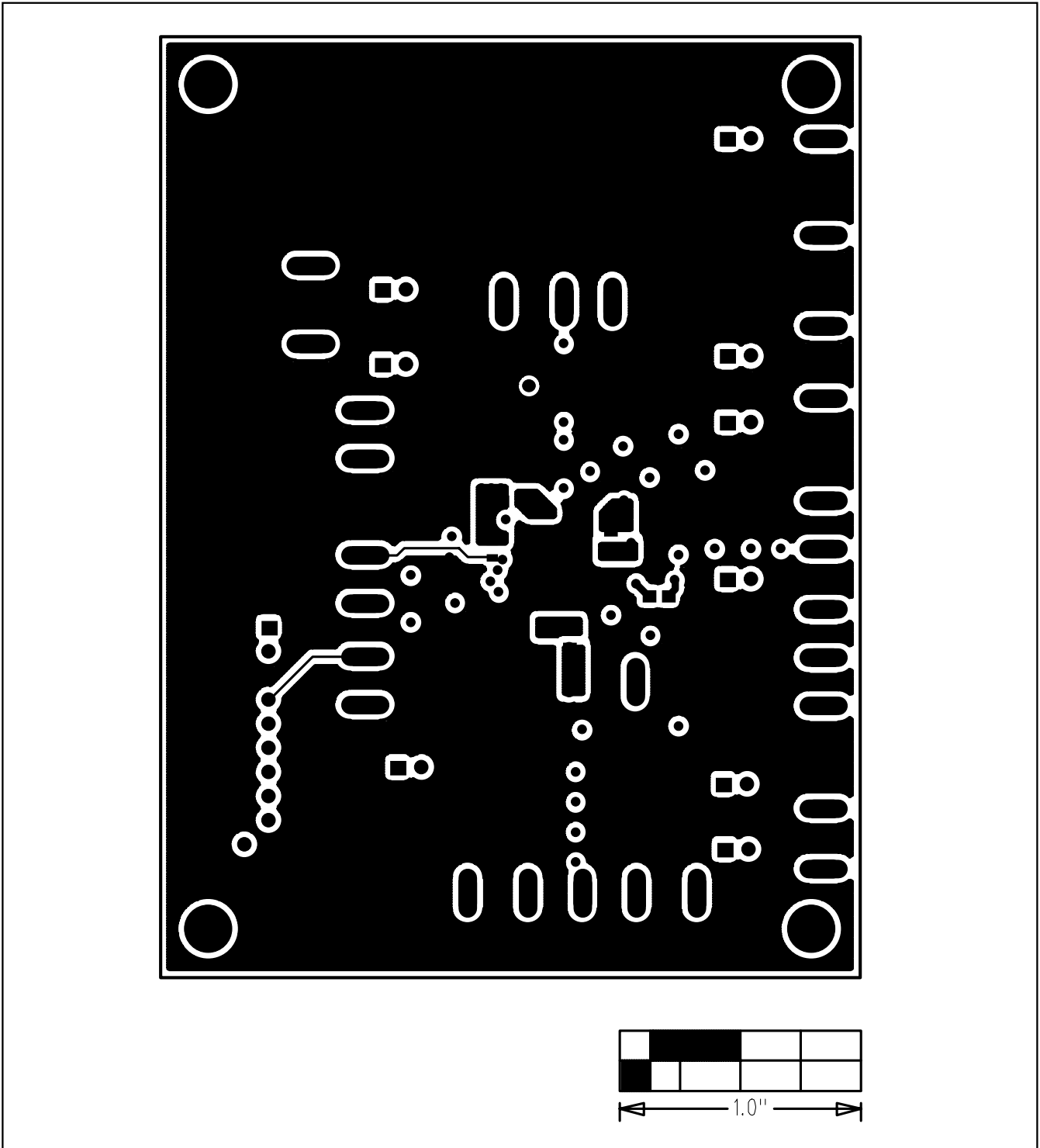

Figure 6. MAX1586A EV Kit PCB Layout—Inner Layer 2

MAX1586A Evaluation Kit/ Evaluation System

Evaluate: MAX1586A

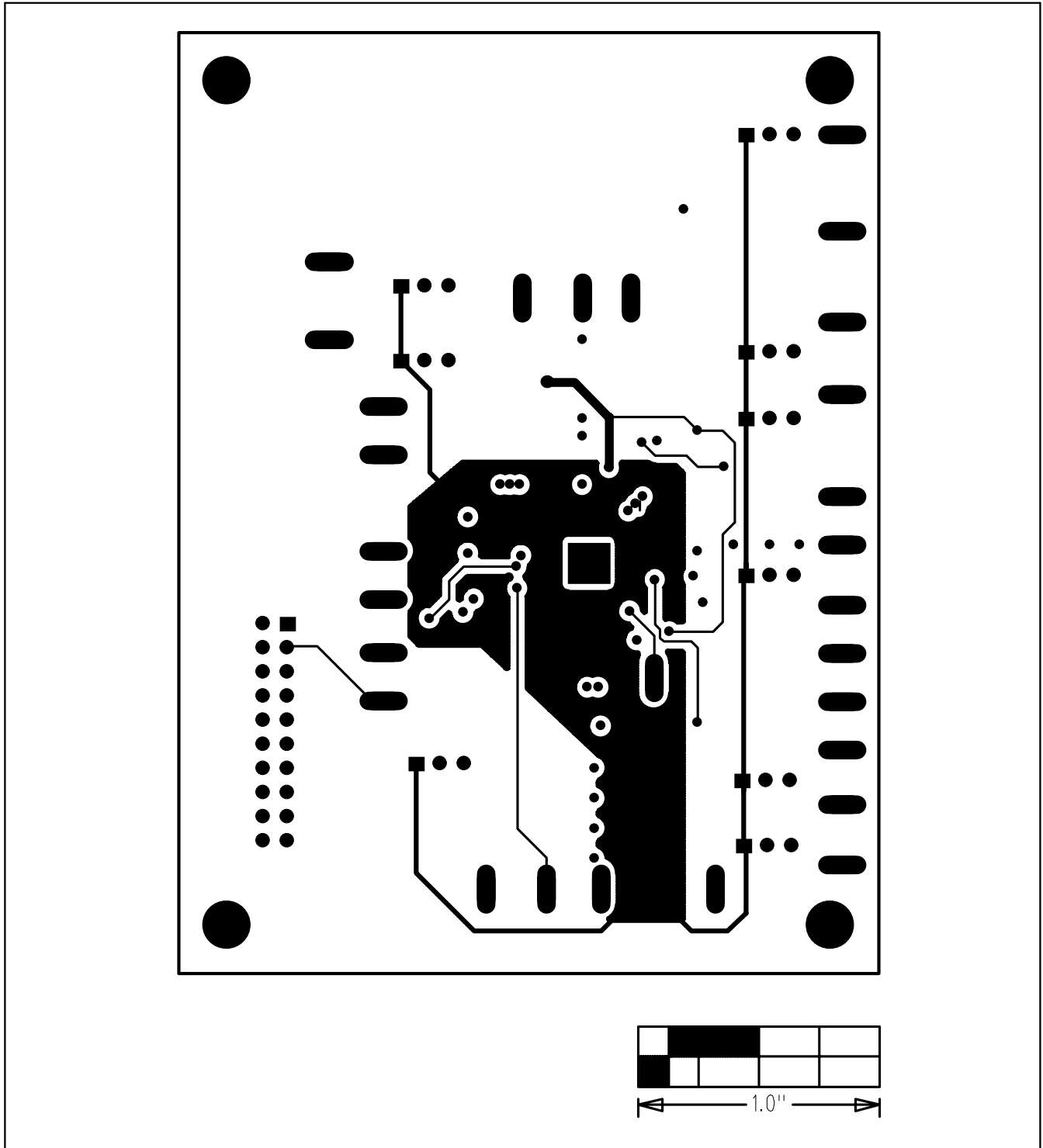

Figure 7. MAX1586A EV Kit PCB Layout—Inner Layer 3

MAX1586A Evaluation Kit/ Evaluation System

Evaluate: MAX1586A

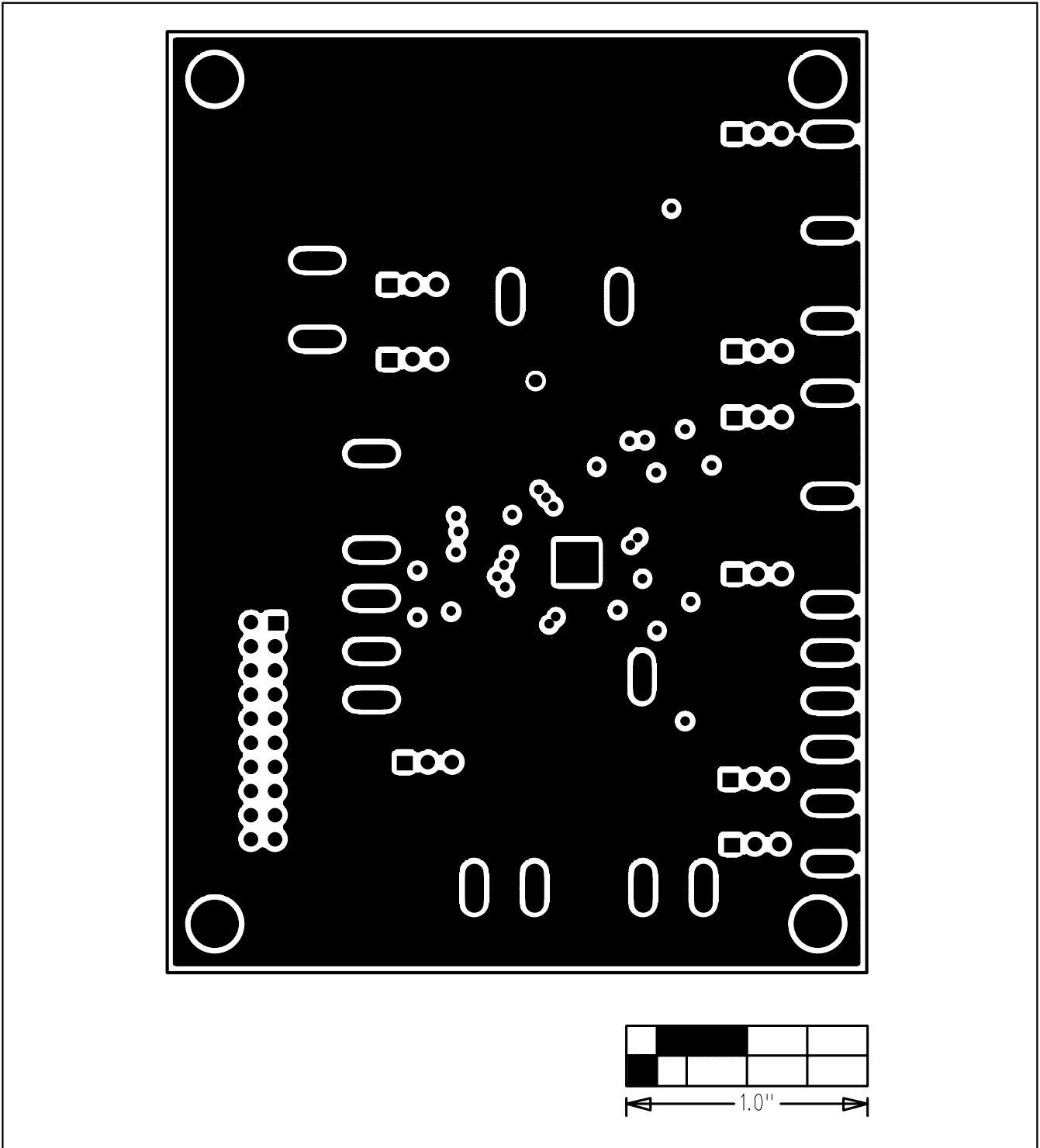

Figure 8. MAX1586A EV Kit PCB Layout—Solder Side

MAX1586A Evaluation Kit/ Evaluation System

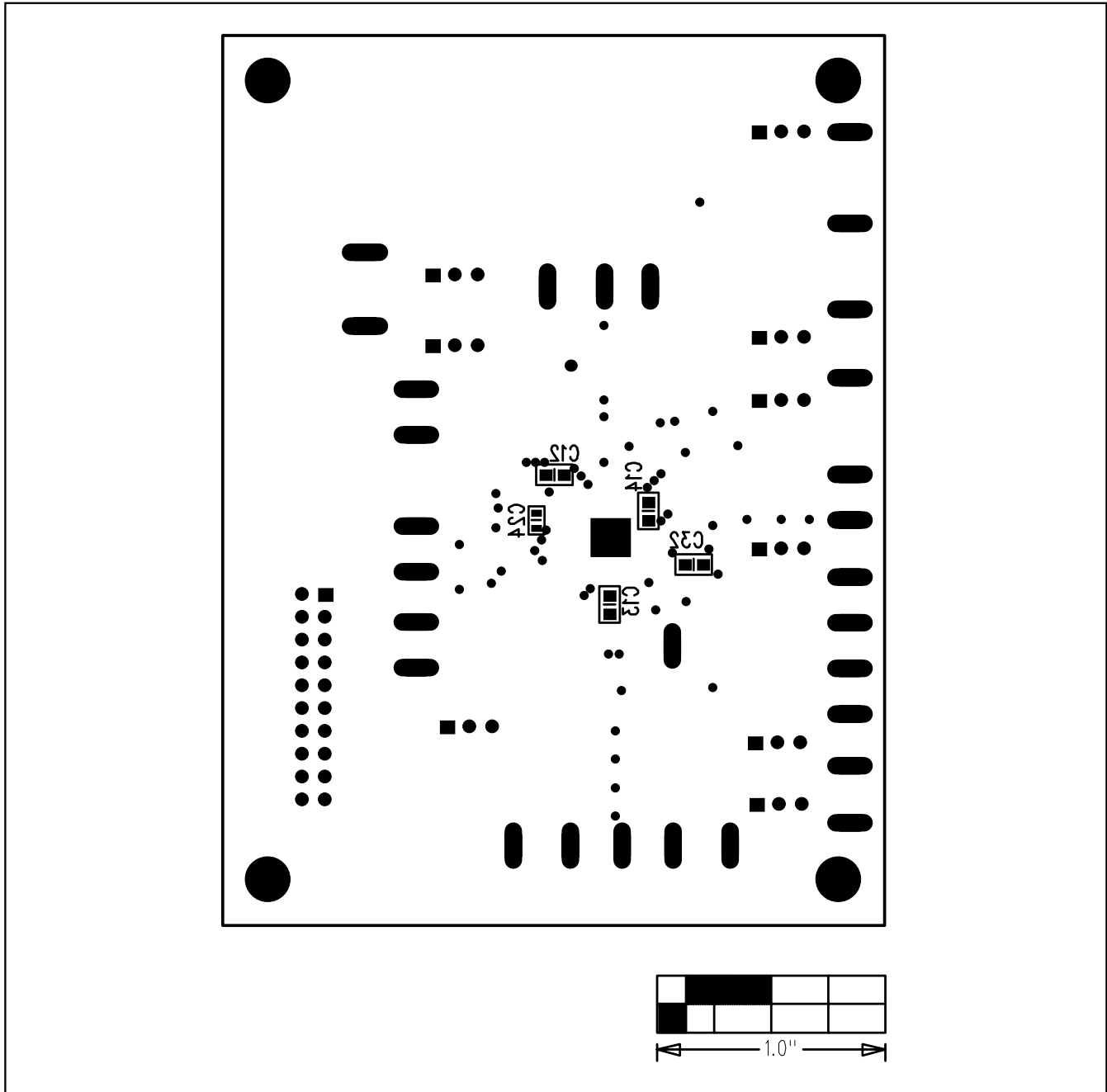

Figure 9. MAX1586A EV Kit Component Placement Guide—Solder Side

Revision History

Pages changed at Rev 1: 1–5, 7, 10–14

Maxim cannot assume responsibility for use of any circuitry other than circuitry entirely embodied in a Maxim product. No circuit patent licenses are implied. Maxim reserves the right to change the circuitry and specifications without notice at any time.

14 Maxim Integrated Products, 120 San Gabriel Drive, Sunnyvale, CA 94086 408-737-7600